

# rezilno orodje brusni papirji



## STARMAN

So ljudje, ki dajo lesu še lepšo obliko in podobo  
in smo ljudje, ki jim pri tem pomagamo in svetujemo.

Tehnični opisi in mere v tem katalogu, tudi tiste s slikami in risbami niso zavezujoče.

Pridružujemo si pravico do oblikovnih izboljšav.

Ne prevzemamo odgovornosti za morebitne tiskarske napake ali druge napake, ki bi se lahko pojavile pri izdelavi kataloga.

Copyright: prepovedana je objava, predelava in kopiranje objavljenih vsebin, brez vednosti Starman d.o.o.

The technical descriptions and dimensions in this catalogue, also those with the photographs and drawings, are not binding.

We reserve the right to make design improvements.























We bear no liability for any misprints or other errors that might occur in the production of this catalogue.

Copyright: It is forbidden to publish, edit and copy published content without the knowledge of Starman d.o.o.



Starman d.o.o.  
Poslovna cona Žeje pri Komendi  
Pod brezami 2, 1218 Komenda  
tel: +386 (0)1 724 79 00  
fax: +386 (0)1 724 79 19  
e-mail: [info@starman.si](mailto:info@starman.si)

## Kazalo

	Listi za krožne žage ..... 2-7		Vpenjalo za sveder, grezila ..... 46-50
	Rezkarji ..... 8-10		Navojne čeljusti, navojni svedri ..... 51
	Nadrezkarji ..... 11-16		Kronske žage, držala kronskih žag ... 52-56
	Noži za rezkarje in skobeljnike ..... 17		Centrirni svedri, vpenjalni trni ..... 57
	Svedri mozničarji ..... 18		Listi za vboodne žage ..... 58-66
	Svedri za les ..... 19-28		Listi za žage lisičji rep ..... 67-70
	Svedri za kovino ..... 29-37		Večfunkcijsko orodje ..... 71-75
	Svedri in dleta SDS za beton ..... 38-42		Rezalke, brusne plošče ..... 76, 77
	Svedri za beton ..... 42, 43		Brusni krožniki ..... 78
	Svedri za keramiko, steklo ..... 43, 44		Brusni papirji, brusni trakovi ..... 79-89
	Večnamenski svedri ..... 44		Pribor za brušenje ..... 90-92
	Diamantni set za vrtanje, pribor ..... 43		

### STAR

#### List za krožno žago

- za običajno uporabo z ročnimi prenosnimi krožnimi žagami
- namenjen za žaganje mehkega in trdega lesa, vezanih plošč, melamina
- zobje so brušeni izmenično levo in desno

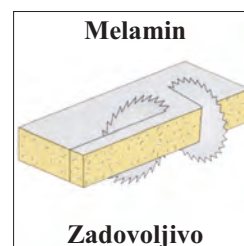
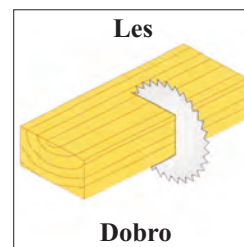
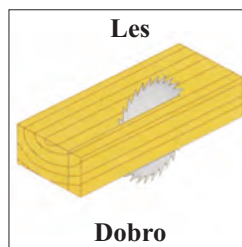
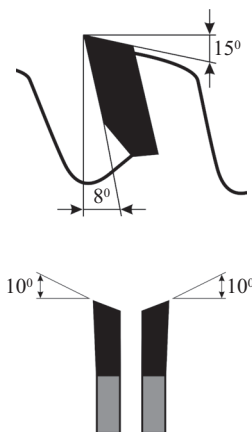

Šifra	Naziv	Premer (ø) mm	Širina reza mm	Debelina mm	Luknja (ø) mm	Število zob
112650	201 Žaga kr. 150 x 2,6/1,6 x 20 mm Z-24 Star	150	2,6	1,6	20	24
112651	202 Žaga kr. 150 x 2,6/1,6 x 20 mm Z-18 Star	150	2,6	1,6	20	18
112652	203 Žaga kr. 160 x 2,6/1,6 x 20 mm Z-24 Star	160	2,6	1,6	20	24
112653	204 Žaga kr. 160 x 2,6/1,6 x 20 mm Z-48 Star	160	2,6	1,6	20	48
112654	205 Žaga kr. 180 x 2,6/1,6 x 20 mm Z-24 Star	180	2,6	1,6	20	24
112655	206 Žaga kr. 180 x 2,6/1,6 x 20 mm Z-52 Star	180	2,6	1,6	20	52
112656	207 Žaga kr. 190 x 2,8/1,8 x 20 mm Z-30 Star	190	2,8	1,8	20	30
112657	208 Žaga kr. 190 x 2,8/1,8 x 20 mm Z-48 Star	190	2,8	1,8	20	48

#### List za krožno žago za vzdolžno rezanje lesa

- za uporabo na miznih žagah in drugih standardnih žagah
- namenjen za vzdolžno žaganje mehkega in trdega lesa
- zobje so brušeni ravno

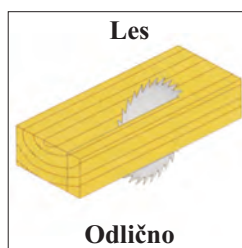
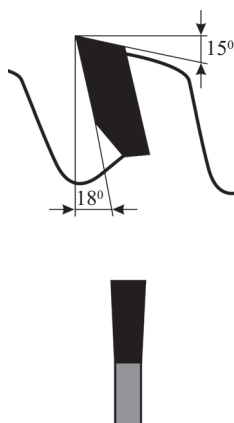

Šifra	Naziv	Premer (ø) mm	Širina reza mm	Debelina mm	Luknja (ø) mm	Število zob
112658	209 Žaga kr. 250 x 3,2/2,2 x 30 mm Z-24 Star	250	3,2	2,2	30	24
112659	210 Žaga kr. 300 x 3,2/2,2 x 30 mm Z-28 Star	300	3,2	2,2	30	28
112660	211 Žaga kr. 350 x 3,5/2,5 x 30 mm Z-32 Star	350	3,5	2,5	30	32

### STAR

#### List za krožno žago

- za uporabo na miznih žagah in drugih standardnih žagah
- zmogljivo žaganje za širok spekter materialov
- namenjen za žaganje mehkega in trdega lesa, vezanih plošč, melamina
- različno število zob za različne uporabe odvisno od tipa materiala, debeline materiala, rezalne hitrosti in kakovosti reza
- zobje so brušeni izmenično levo in desno

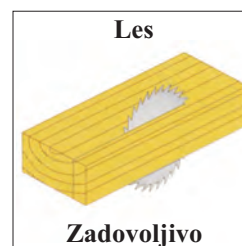
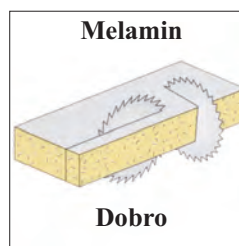
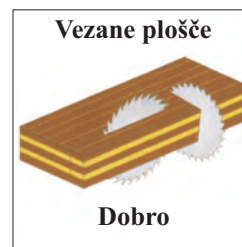
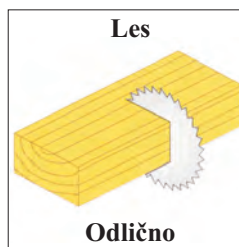
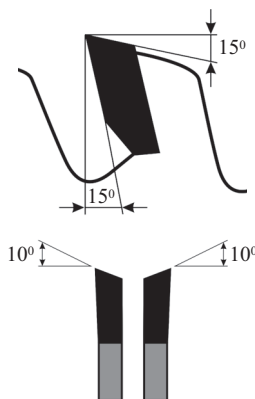

Šifra	Naziv	Premer (ø) mm	Širina reza mm	Debelina mm	Luknja (ø) mm	Število zob
112661	212 Žaga kr. 250 x 3,2/2,2 x 30 mm Z-60 Star	250	3,2	2,2	30	60
112662	213 Žaga kr. 300 x 3,2/2,2 x 30 mm Z-48 Star	300	3,2	2,2	30	48
112663	214 Žaga kr. 300 x 3,2/2,2 x 30 mm Z-72 Star	300	3,2	2,2	30	72
112664	215 Žaga kr. 350 x 3,5/2,5 x 30 mm Z-54 Star	350	3,5	2,5	30	54
112665	216 Žaga kr. 350 x 3,5/2,5 x 30 mm Z-72 Star	350	3,5	2,5	30	72
112666	217 Žaga kr. 350 x 3,5/2,5 x 30 mm Z-84 Star	350	3,5	2,5	30	84

#### List za krožno žago

- za uporabo na miznih žagah za rez razrez iveralov v kombinaciji s predrezilom
- namenjen za žaganje ivernih plošč, vezanih plošč, melamina
- zobje so brušeni izmenično trapezno in ravno

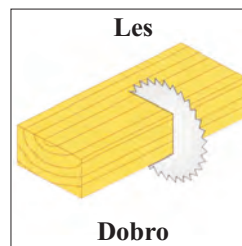
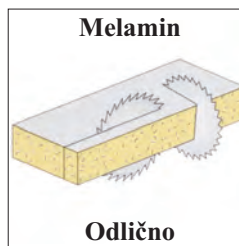
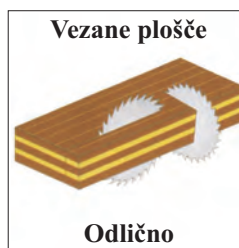
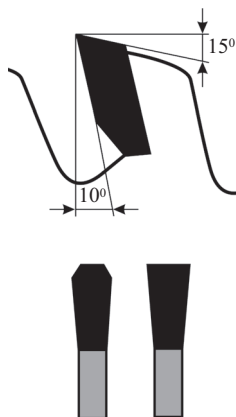

Šifra	Naziv	Premer (ø) mm	Širina reza mm	Debelina mm	Luknja (ø) mm	Število zob
112667	218 Žaga kr. 250 x 3,2/2,2 x 30 mm Z-80 Star	250	3,2	2,2	30	80
112668	219 Žaga kr. 300 x 3,2/2,2 x 30 mm Z-96 Star	300	3,2	2,2	30	96
112669	220 Žaga kr. 350 x 3,5/3,5 x 30 mm Z-108 Star	350	3,5	3,5	30	108

### STAR

#### Listi za krožne žage

- za uporabo na miznih žagah in drugih standardnih žagah
- namenjen za žaganje vezanih plošč, furniranih ivernih plošč, melamina, prečni rez lesa
- zobje so brušeni izmenično levo in desno

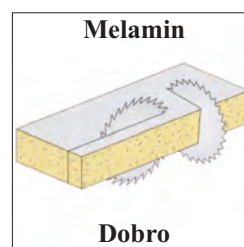
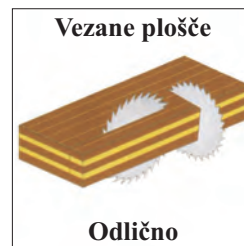
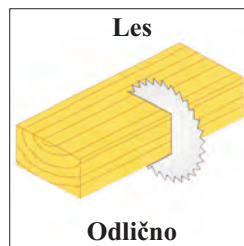
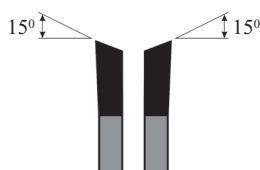
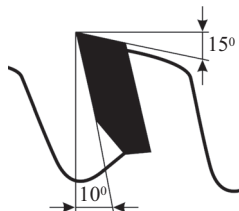

Šifra	Naziv	Premer (ø) mm	Širina reza mm	Debelina lista mm	Luknja (ø) mm	Število zob
112670	221 Žaga kr. 250 x 3,2/2,2 x 30 mm Z-80	250	3,2	2,2	30	80
112671	222 Žaga kr. 300 x 3,2/2,2 x 30 mm Z-96	300	3,2	2,2	30	96
112672	223 Žaga kr. 350 x 3,5/2,5 x 30 mm Z-108	350	3,5	2,5	30	108

### freud

#### Listi za krožne žage

- za uporabo na miznih žagah in drugih standardnih žagah
- namenjen za žaganje melamina (brez predrezila)
- zobje so brušeni izmenično levo in desno

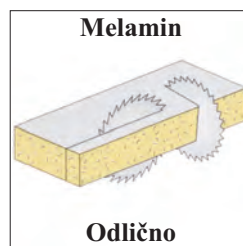
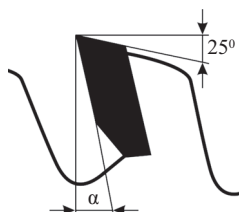

Šifra	Naziv	Premer (ø) mm	Širina reza mm	Debelina lista mm	Luknja (ø) mm	Kot α	Število zob
114901	LU3A0200 250 x 3,2 x 30 mm Z-80	250	3,2	2,2	30	-2°	80
114903	LU3A0300 300 x 3,2 x 30 mm Z-96	300	3,2	2,2	30	2°	96
114902	LU3A0400 350 x 3,5 x 30 mm Z-108	350	3,5	2,5	30	5°	108



### List za krožno žago

- za uporabo na miznih žagah in drugih standardnih žagah
- namenjen za žaganje melamina
- zobje so brušeni izmenično trapezno in ravno

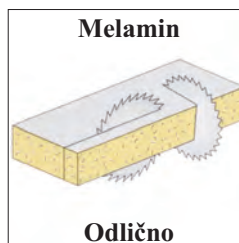
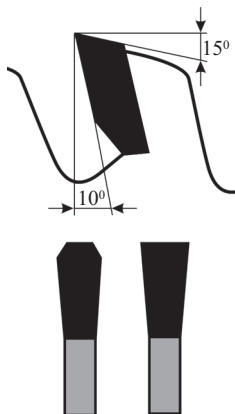

Šifra	Naziv	Premer (ø) mm	Širina reza mm	Debelina lista mm	Luknja (ø) mm	Število zob
115630	S123 Žaga za iveral 300x3,2x30 mm Z-96	300	3,2	2,2	30	96

### List za krožno žago

- namenjen za žaganje melamina
- zobje so brušeni ravno

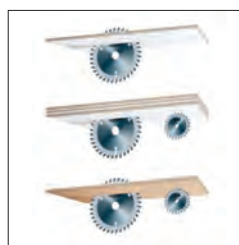
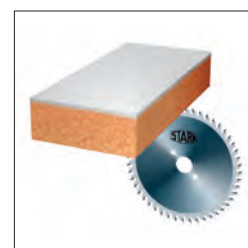
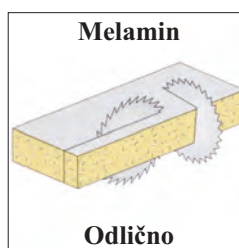
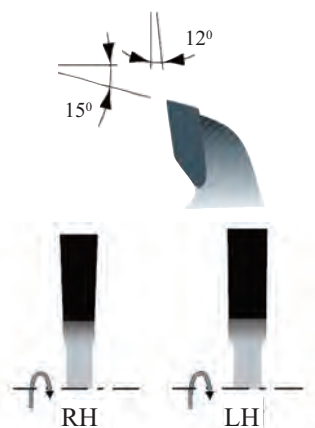

Šifra	Naziv	Premer (ø) mm	Širina reza mm	Debelina lista mm	Luknja (ø) mm	Število predrezil	Število zob
115594	I20 Predrezilo 100x2,8/3,6x20 Z-24	100	2,8		20	12	12



### Listi EASY CUT za ročne krožne žage

- prihranek energije in časa 30%
- optimizirana geometrija rezila
- tanko rezilo zmanjša debelino rezanja
- manj trenja, varčevanje z energijo in časom
- manjša obremenitev za baterijske krožne žage



Utori za hitrejše in boljše delovanje. Natančni in čisti rezi. Posebno primerni za ročne baterijske krožne žage, ker prihranijo 30 % časa pri delu, kar pomeni daljši čas uporabe z isto baterijo. Uporabni za vse namene. Za iverne plošče, obložene iverne plošče, gradbeni les, barvne kovine, pločevine, aluminijaste profile, plastiko, akrilno steklo, les z ostanki kovin.



Šifra	Naziv	Premer (ø) mm	Širina reza mm	Luknja (ø) mm	Število zob
192277	5819-38 Žagin list 135x1,8x20 mm KWB	135	1,8	20	24
192278	5845-38 Žagin list 160x1,8x20 mm KWB	160	1,8	20	24
192279	5847-38 Žagin list 165x2,0x20 mm KWB	165	2,0	20	24
192280	5855-38 Žagin list 173x2,0x30 mm KWB	173	2,0	30	24





### Listi za ročne krožne žage

		Premer (Ø) mm	Luknja (Ø) mm	Število zob	Širina reza mm	Masiven les	Iverne plošče	MDF, vlaknene plošče	Iveral	Blok plošče	Vezane plošče, OSB plošče	Plastika	Mavčne plošče	Neželezne kovine, profili	Čist in fin rez
Šifra	Naziv														
155925	4932 2563 88 Žaga krožna 190x30x48Z	190	30	48	2,8	X	X	X	X	X	X	X	X		X
155927	4932 2591 36 Žaga krožna 210x30x48Z	210	30	48	2,8	X	X	X	X	X	X	X	X		X
155924	4932 3279 69 Žaga krožna 190x30x24Z	190	30	24	2,4	X	X	X	X	X	X	X	X		
155926	4932 3465 12 Žaga krožna 190x30x54Z	190	30	54	2,8	X	X		X	X	X	X	X	X	X
155928	4932 3465 13 Žaga krožna 210x30x54Z	210	30	54	2,8	X	X		X	X	X	X		X	X
155919	4932 3521 31 Žaga krožna 165x20x24Z	165	20	24	2,6	X	X	X	X	X	X	X	X		
155920	4932 3521 32 Žaga krožna 165x20x52Z	165	20	52	2,8	X	X	X	X	X	X	X	X		X
155019	4932 3523 13 Žaga krožna 165x15,8x24Z	165	15,8	24	1,6	X	X	X	X	X	X				
155020	4932 3523 14 Žaga krožna 165x15,8x40Z	165	15,8	40	1,6	X	X	X	X	X	X				X
155921	4932 3523 27 Žaga krožna 184x30x24Z	184	30	24	1,8	X	X	X	X	X	X	X	X		
155922	4932 3523 28 Žaga krožna 184x30x54Z	184	30	54	1,8	X	X	X	X	X	X	X	X		X
155923	4932 3523 29 Žaga krožna 184x30x54Z	184	30	54	2,0	X	X	X	X	X	X	X	X	X	X



## Rezkar za smoliko



Šifra	Naziv	D (ø) mm	B mm	d (ø) mm	Število zob	Obrati min
115589	6IN03TM02022 Rezkar za smoliko	100	8	22	4	7600-13400

## Rezkar za lamelo

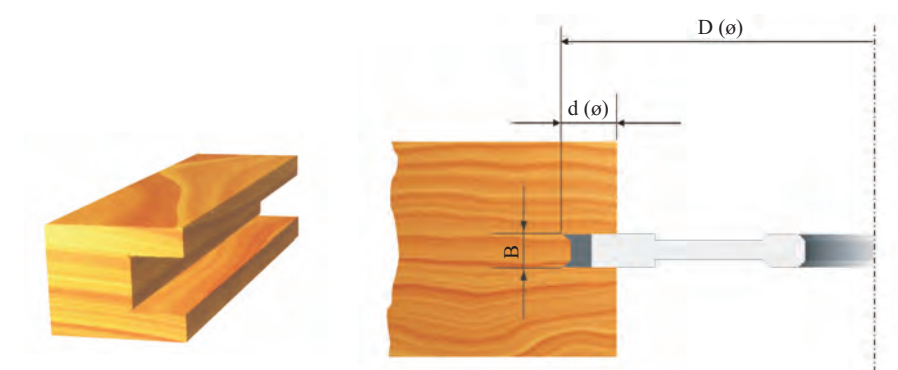

Šifra	Naziv	D (ø) mm	B mm	d (ø) mm	Število zob	Število predrezil	Obrati min
115595	6IN03TM01022 Rezkar za lamelo	100	3,95	22	2	4	7600-13400

## Rezkar IR10TM01/02

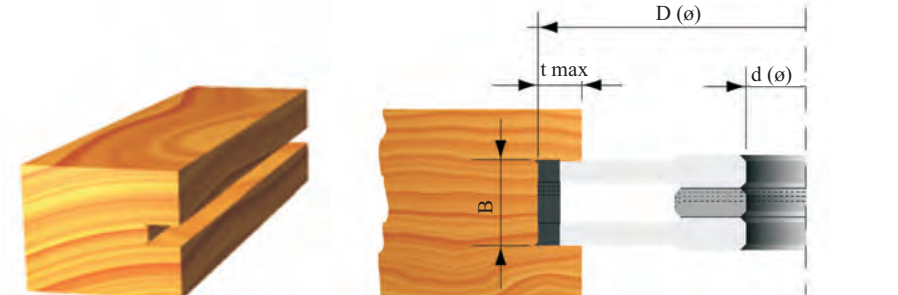

Šifra	Naziv	D (ø) mm	B mm	d (ø) mm	t max mm	Število zob	Število predrezil	Obrati min
115022	IR10TM01030 Rezkar 140x1,8-3,4x30 mm	140	1,8-3,4	30	15	4	4	5500-9500
115023	IR10TM02030 Rezkar 140x2,5-4,8x30 mm	140	2,5-4,8	30	15	4	4	5500-9500



## Rezkar IR20TM01/02

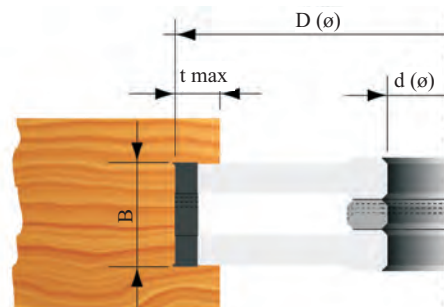

Šifra	Naziv	D (ø) mm	B mm	d (ø) mm	Število zob	Število predrezil	Obrati min
115017	IR20TM01 Rezkar 160x4-7,5x30 mm	160	4-7,5	30	4	4	5100-9000
115018	IR20TM02 Rezkar 160x7,5-14x30 mm	160	7,5-14	30	4	4	5100-9000

## Rezkar TH02TM04

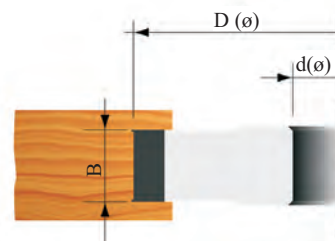

Šifra	Naziv	D (ø) mm	B mm	d (ø) mm	Število zob	Število predrezil	Obrati min
115015	TH02TM04 Rezkar 125x50x30 mm	125	50	30	4	4	6100-10700
115016	TH02TM04 Rezkar 125x50x35 mm	125	50	35	4	4	6100-10700

## Rezkar TH17TM20

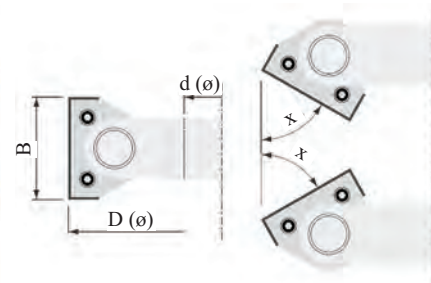
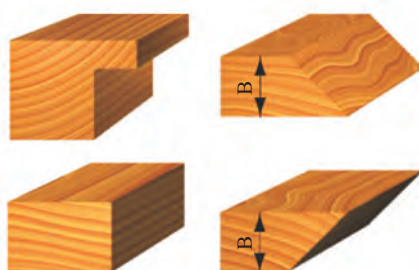

Šifra	Naziv	D (ø) mm	B mm	d (ø) mm	Število zob	d max (ø) mm	x	Obrati min
115028	YH140ACM030 Rezkar 0-60° 140x40x30 mm	140	40	30	2	40	0-60°	5000-7500
115014	TH17TM20 Rezkar 0-70° 160x50x30 mm	160	50	30	2	50	0-70°	5000-7500
115013	TH17TM20 Rezkar 0-70° 160x50x35 mm	160	50	35	2	50	0-70°	5000-7500



### Rezkar TH22TM21/22

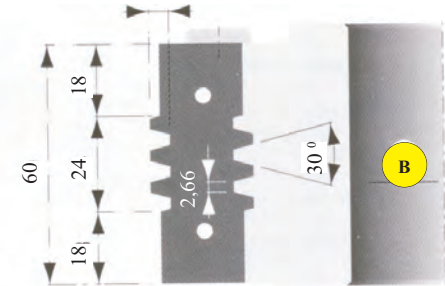
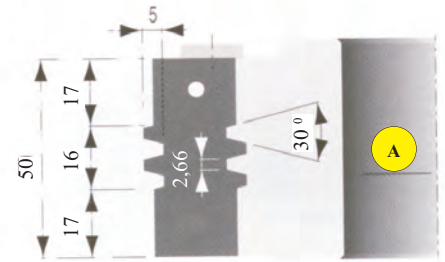
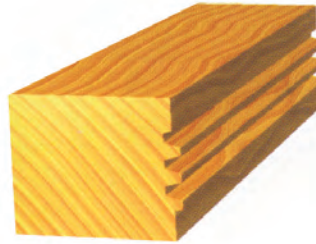

Šifra	Naziv	D (ø) mm	B mm	d (ø) mm	d max (ø) mm	Število zob	Obrati min	Slika zgoraj
115026	TH22TM21030 Rezkar 135x50x30 mm	135	50	30	50	2	5600-9500	
115027	TH22TM22030 Rezkar 135x60x30 mm	135	60	30	50	2	5600-9500	
115073	602001 Rezilo HM tip-A							A
110662	602002 Rezilo HM tip-B							B

### Profilna glava TH70TM

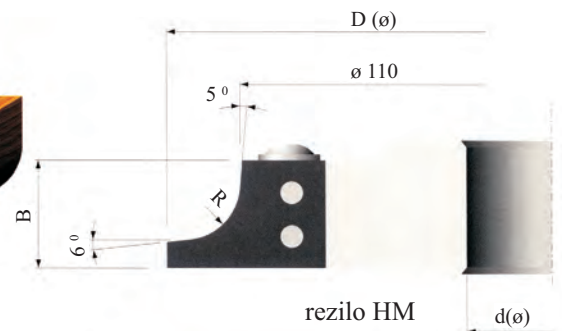
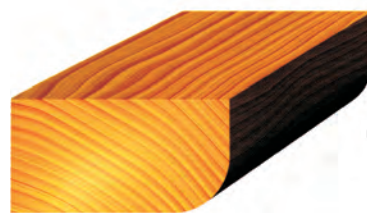

Šifra	Naziv	D (ø) mm	B mm	d (ø) mm	d max (ø) mm	Število zob	R mm	Obrati min
115024	TH70TM10030 Profilna glava	132	20	30	50	2		5800-9000
115067	601451 Rezilo HM 20x25 mm R = 3 mm						3	
115068	601452 Rezilo HM 20x25 mm R = 4 mm						4	
115069	601453 Rezilo HM 20x25 mm R = 5 mm						5	
115070	601454 Rezilo HM 20x25 mm R = 6 mm						6	
115071	601455 Rezilo HM 20x25 mm R = 8 mm						8	
115072	601456 Rezilo HM 20x25 mm R = 10 mm						10	

#### - komplet vsebuje:

- profilna glava TH70TM
- rezila HM 20x25 mm z radiji: 3, 4, 5, 6, 8, 10 mm
- lesena škatla

## STAR

### Nadrezkar HM

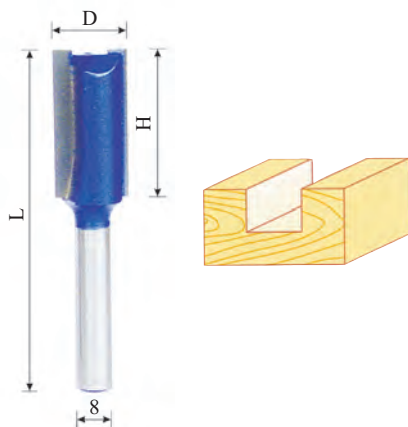

Šifra	Naziv	D ( $\emptyset$ ) mm	H mm	L mm
112500	001 Nadrezkar HM 001060 Star	6	16	49
112501	002 Nadrezkar HM 001060-1 Star	6	20	54
112502	003 Nadrezkar HM 001080 Star	8	20	54
112503	004 Nadrezkar HM 001100 Star	10	20	54
112504	005 Nadrezkar HM 001120 Star	12	20	54
112505	006 Nadrezkar HM 001140 Star	14	20	54
112506	007 Nadrezkar HM 001160 Star	16	20	54
112507	008 Nadrezkar HM 001180 Star	18	20	54
112508	009 Nadrezkar HM 001180-1 Star	18	25	59
112509	010 Nadrezkar HM 001200 Star	20	20	54
112510	011 Nadrezkar HM 001200-1 Star	20	25	59
112511	012 Nadrezkar HM 001250-1 Star	25	25	59

### Nadrezkar HM

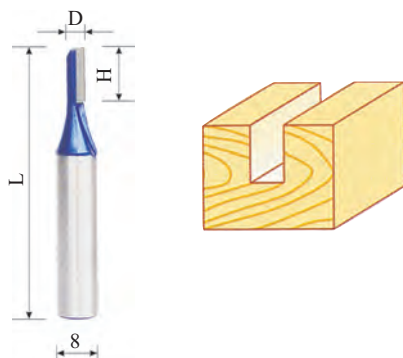

Šifra	Naziv	D ( $\emptyset$ ) mm	H mm	L mm
112512	013 Nadrezkar HM 011040 Star	4	9,5	45

### Nadrezkar HM

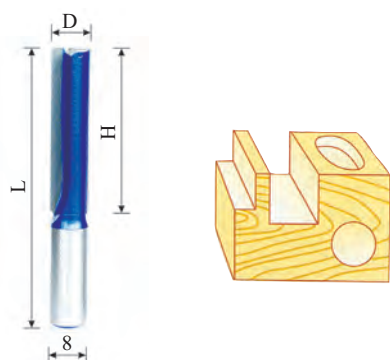

Šifra	Naziv	D ( $\emptyset$ ) mm	H mm	L mm
112513	014 Nadrezkar HM 021100 Star	10	20	54
112514	015 Nadrezkar HM 021120-1 Star	12	38	73
112515	016 Nadrezkar HM 021160-1 Star	16	38	73
112516	017 Nadrezkar HM 021180-1 Star	18	25	59
112517	018 Nadrezkar HM 021200 Star	20	20	54
112518	019 Nadrezkar HM 021220 Star	22	20	54
112519	020 Nadrezkar HM 021250-1 Star	25	25	59

### Nadrezkar HM

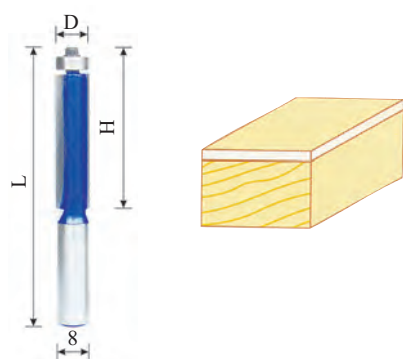

Šifra	Naziv	D ( $\emptyset$ ) mm	H mm	L mm
112520	021 Nadrezkar HM 301127 Star	12,7	13	57
112521	022 Nadrezkar HM 301127-1 Star	12,7	25	70
112522	023 Nadrezkar HM 301127-2 Star	12,7	32	76
112523	024 Nadrezkar HM 301160-1 Star	16	32	76

### STAR

#### Nadrezkar HM

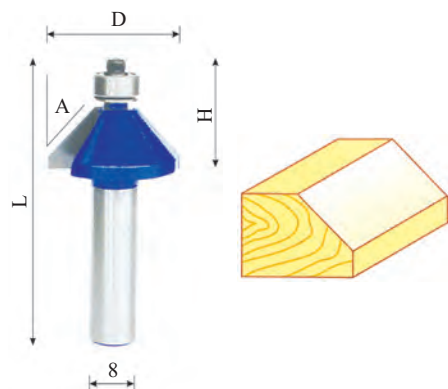

Šifra	Naziv	D ( $\emptyset$ ) mm	H mm	L mm	A °
112524	025 Nadrezkar HM 131222 Star	22,2	22,2	68	11,25
112526	027 Nadrezkar HM 131286 Star	28,6	7,9	57	45
112525	026 Nadrezkar HM 131310 Star	31,1	22,2	68	22,5
112527	028 Nadrezkar HM 131320 Star	32	9,5	57	45
112528	029 Nadrezkar HM 131381 Star	38,1	12,7	62	45

#### Nadrezkar HM

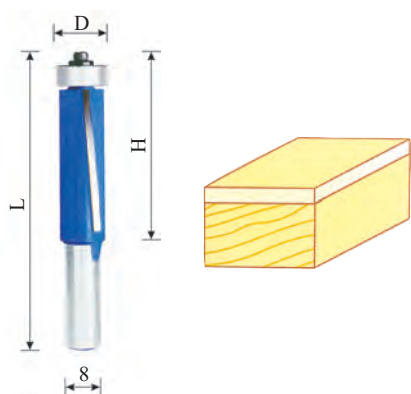

Šifra	Naziv	D ( $\emptyset$ ) mm	H mm	L mm
112529	030 Nadrezkar HM 30127L Star	12,7	25	70

#### Nadrezkar HM

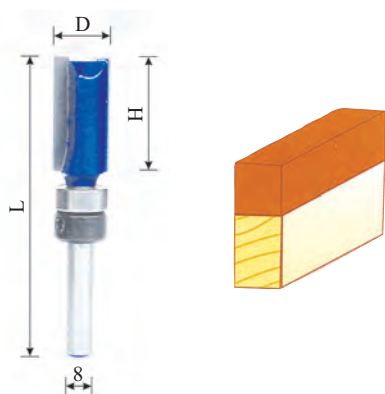

Šifra	Naziv	D ( $\emptyset$ ) mm	H mm	L mm
112530	031 Nadrezkar HM 321190-1 Star	19	25	67

#### Nadrezkar HM

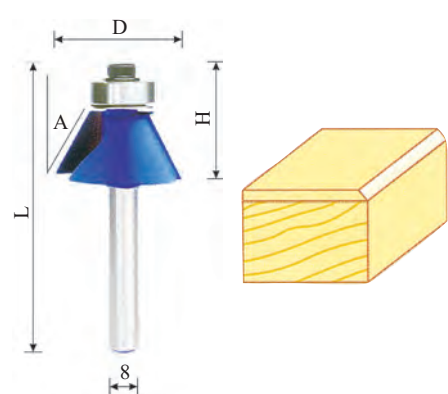

Šifra	Naziv	D ( $\emptyset$ ) mm	H mm	L mm	A °
112531	032 Nadrezkar HM 351156 Star	15,6	10,3	54	8
112532	033 Nadrezkar HM 351222 Star	22,4	12	57	22

### STAR

#### Nadrezkar HM

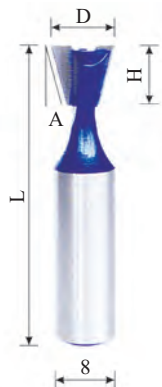

Šifra	Naziv	D ( $\emptyset$ ) mm	H mm	L mm	A °
112533	034 Nadrezkar HM 101063 Star	6,3	6,3	44	8
112534	035 Nadrezkar HM 101095 Star	9,5	9,5	48	9

#### Nadrezkar HM

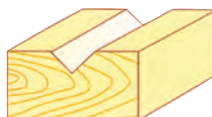
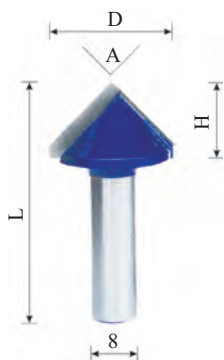

Šifra	Naziv	D ( $\emptyset$ ) mm	H mm	L mm	A °
112535	036 Nadrezkar HM 111063 Star	6,35	8	43	90
112536	037 Nadrezkar HM 111095 Star	9,5	12,7	48	90
112537	038 Nadrezkar HM 111127 Star	12,7	12,7	48	90
112538	039 Nadrezkar HM 111190 Star	19	16	51	90

#### Nadrezkar HM

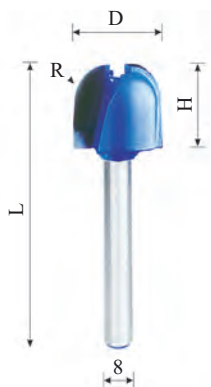

Šifra	Naziv	D ( $\emptyset$ ) mm	H mm	L mm	R mm
112539	040 Nadrezkar HM 191111 Star	11,1	12,7	46	3,2
112540	041 Nadrezkar HM 191190 Star	19	16	51	6,3

#### Nadrezkar HM

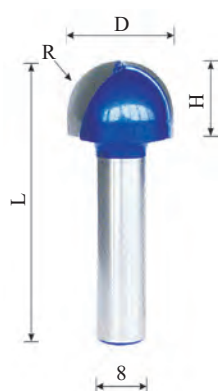

Šifra	Naziv	D ( $\emptyset$ ) mm	H mm	L mm	R mm
112541	042 Nadrezkar HM 401095 Star	9,5	9,5	45	4,8
112542	043 Nadrezkar HM 401127 Star	12,7	9,5	45	6,3
112543	044 Nadrezkar HM 401159 Star	15,9	12,7	48	8
112544	045 Nadrezkar HM 401190 Star	19	12,7	48	9,5

### STAR

#### Nadrezkar HM

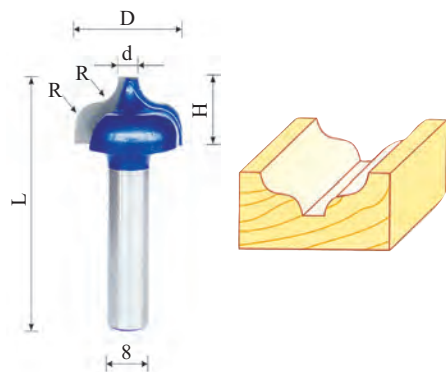

Šifra	Naziv	D ( $\emptyset$ ) mm	H mm	L mm	R mm	d mm
112545	046 Nadrezkar HM 441099 Star	9,9	9,5	45	1,6	3,6
112546	047 Nadrezkar HM 441162 Star	16,2	12,7	48	3,2	3,6
112547	048 Nadrezkar HM 441238 Star	23,8	12,7	48	4,8	4,8

#### Nadrezkar HM

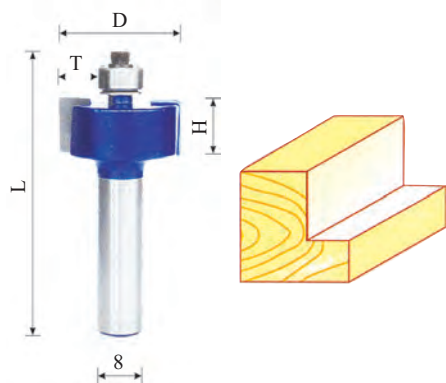

Šifra	Naziv	D ( $\emptyset$ ) mm	H mm	L mm	T mm
112548	049 Nadrezkar HM 151190 Star	19	12,7	57	3,2
112549	050 Nadrezkar HM 151254 Star	25,4	12,7	57	6,3
112550	051 Nadrezkar HM 151285 Star	28,5	12,7	57	8
112551	052 Nadrezkar HM 151318 Star	31,8	12,7	57	9,5
112552	053 Nadrezkar HM 151381 Star	38,1	12,7	57	12,7

#### Nadrezkar HM

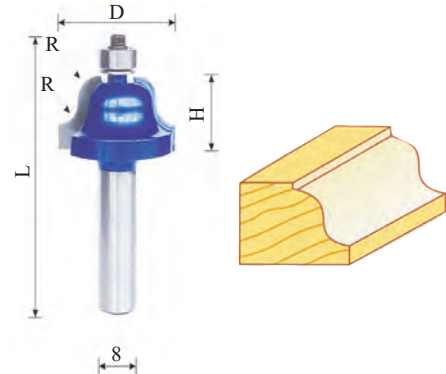

Šifra	Naziv	D ( $\emptyset$ ) mm	H mm	L mm	R mm
112553	054 Nadrezkar HM 411286 Star	28,6	12,7	56	4

#### Nadrezkar HM

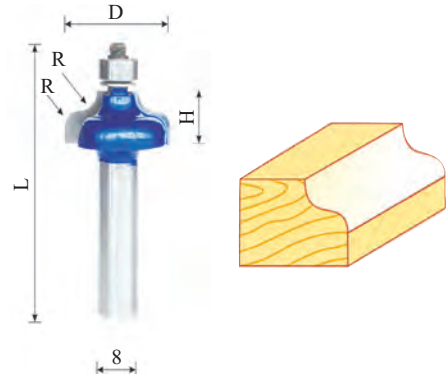

Šifra	Naziv	D ( $\emptyset$ ) mm	H mm	L mm	R mm
112554	055 Nadrezkar HM 421318 Star	31,8	12,7	56	4,8



## STAR

### Nadrezkar HM

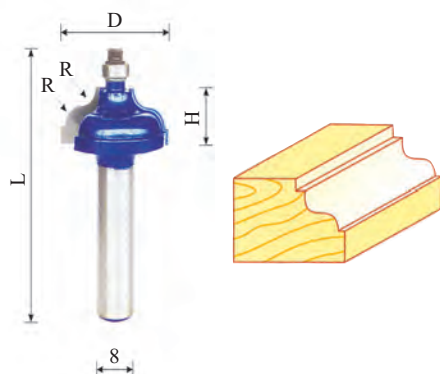

Šifra	Naziv	D ( $\emptyset$ ) mm	H mm	L mm	R mm
112555	056 Nadrezkar HM 491350 Star	35	14,3	57	4,8

### Nadrezkar HM

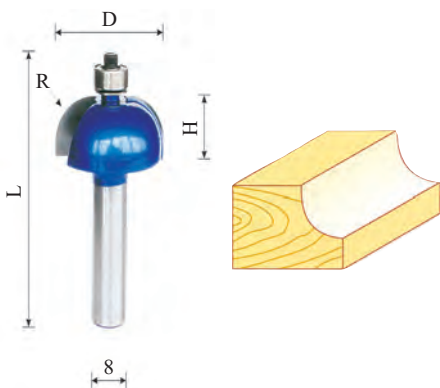

Šifra	Naziv	D ( $\emptyset$ ) mm	H mm	L mm	R mm
112556	057 Nadrezkar HM 561222 Star	22,2	12,7	55,5	4,8
112557	058 Nadrezkar HM 561254 Star	25,4	12,7	55,5	6,35
112558	059 Nadrezkar HM 561285 Star	28,5	12,7	55,5	8

### Nadrezkar HM

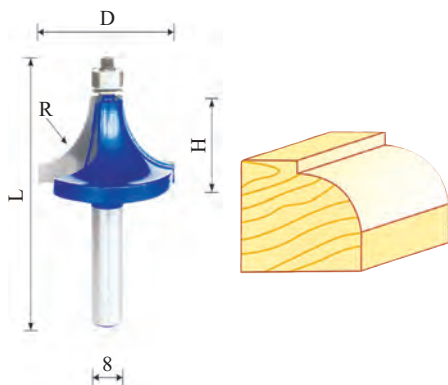

Šifra	Naziv	D ( $\emptyset$ ) mm	H mm	L mm	R mm
112559	060 Nadrezkar HM 591159 Star	15,9	7,9	51	1,6
112560	061 Nadrezkar HM 591167 Star	16,7	8,7	54	2,0
112573	073 Nadrezkar HM 591187 Star	18,7	10,5	52	3,0
112561	062 Nadrezkar HM 591190 Star	19	10,3	54	3,2
112562	063 Nadrezkar HM 591254 Star	25,4	13,5	57	6,35
112563	064 Nadrezkar HM 591286 Star	28,6	15,9	59	7,9
112564	065 Nadrezkar HM 591318 Star	31,8	16,7	62	9,5
112565	066 Nadrezkar HM 591381 Star	38,1	19	64	12,7
112566	067 Nadrezkar HM 591445 Star	44,5	22,2	67	15,9

### Nadrezkar HM

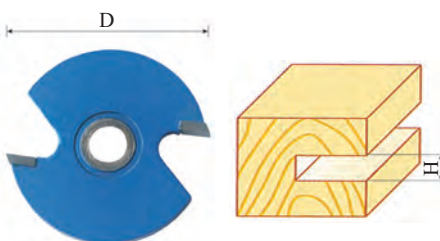

Šifra	Naziv	D ( $\emptyset$ ) mm	H mm
112571	072 Nadrezkar HM 071476B-2 Star	47,6	2
112567	068 Nadrezkar HM 071476B-3 Star	47,6	3
112568	069 Nadrezkar HM 071476B-4 Star	47,6	4
112569	070 Nadrezkar HM 071476B-5 Star	47,6	5

### STAR

#### Držalo nadrezkarja

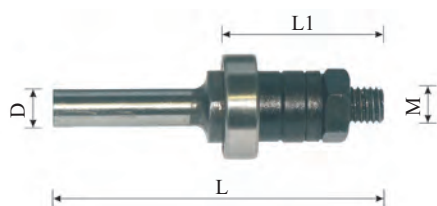

Šifra	Naziv	L mm	L1 mm	D ( $\emptyset$ ) mm	M
112570	071 Nadrezkar HM DB 12	68,5	33,5	8	M 8

### FAMAE

#### Nadrezkarji - profi



Šifra	Naziv
076282	3383-812 Nadrezkarji 12 delni profi

- vpetje:  $\emptyset$  8 mm
- kakovostni kroglični ležaji za odlično kontrolo in vrtenje
- set vsebuje nadrezkarje:
  - $\emptyset$  8 x 20 mm
  - $\emptyset$  12 x 20 mm
  - $\emptyset$  12 x R6 mm
  - $\emptyset$  16 x 20 mm
  - $\emptyset$  12,7 mm/90°
  - $\emptyset$  14,3 mm/14°
  - $\emptyset$  12,7 x 25,4 mm z ležajem
  - $\emptyset$  21,5 x R6 mm z ležajem
  - $\emptyset$  24,7 x R6 mm z ležajem
  - $\emptyset$  27 x R4 mm z ležajem
  - $\emptyset$  28 mm/45° z ležajem
  - $\emptyset$  32,7 x R10 mm z ležajem
- v PVC kaseti



### Nož za rezkar

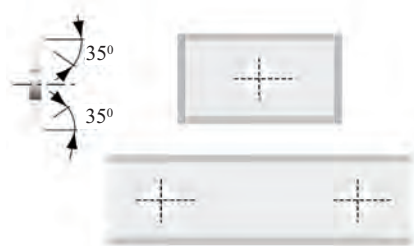

Šifra	Naziv	Dolžina mm	Višina mm	Debelina mm	Kot
113777	CG01M AA3 7,65x12x1,5 HM Plošč.	7,65	12	1,5	35°
113781	CG01M CA3 15x12x1,5 HM Plošč.	15	12	1,5	35°
113782	CG01M DA3 20x12x1,5 HM Plošč.	20	12	1,5	35°
113784	CG01M EA3 30x12x1,5 HM Plošč.	30	12	1,5	35°
113783	CG01M LA3 40x12x1,5 HM Plošč.	40	12	1,5	35°
113786	CG01M GA3 60x12x1,5 HM Plošč.	60	12	1,5	35°

### Nož za skobeljnik



Šifra	Naziv	Dolžina mm	Višina mm	Debelina mm
114275	Skobeljni nož 18W 300x30x3 mm	300	30	3
114255	Skobeljni nož 18W 300x35x3 mm	300	35	3
114274	Skobeljni nož 18W 350x30x3 mm	350	30	3
114273	Skobeljni nož 18W 350x35x3 mm	350	35	3
114277	Skobeljni nož 18W 400x30x3 mm	400	30	3
114257	Skobeljni nož 18W 400x35x3 mm	400	35	3
114278	Skobeljni nož 18W 410x30x3 mm	410	30	3
114258	Skobeljni nož 18W 410x35x3 mm	410	35	3
114281	Skobeljni nož 18W 500x30x3 mm	500	30	3
114259	Skobeljni nož 18W 500x35x3 mm	500	35	3
114260	Skobeljni nož 18W 510x30x3 mm	510	30	3
114280	Skobeljni nož 18W 510x35x3 mm	510	35	3
114282	Skobeljni nož 18W 600x30x3 mm	600	30	3
114263	Skobeljni nož 18W 600x35x3 mm	600	35	3
114283	Skobeljni nož 18W 610x30x3 mm	610	30	3
114264	Skobeljni nož 18W 610x35x3 mm	610	35	3
114284	Skobeljni nož 18W 650x30x3 mm	650	30	3
114266	Skobeljni nož 18W 650x35x3 mm	650	35	3
114268	Skobeljni nož 18W 1000x30x3 mm	1000	30	3
114285	Skobeljni nož 18W 1000x35x3 mm	1000	35	3

### Nož za skobeljnik

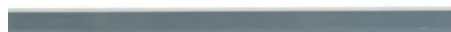

Šifra	Naziv	Dolžina mm	Višina mm	Debelina mm
112330	6000SP-KF75 ZB75 Nož HW 75,5x5,5x1,1 mm 35°	75,5	5,5	1,1
112331	86000SP ZB80 Nož HW 80x5,9x1,2 mm 45°	80	5,9	1,2
112332	86000SP ZB82 Nož HW 82x5,5x1,1 mm 35°	82	5,5	1,1



### Sveder mozničar

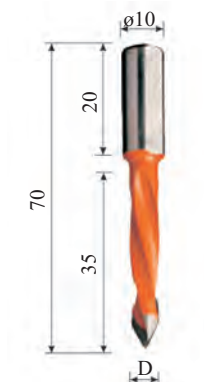

Šifra	Naziv	D (ø) mm
111355	Sveder mozničar 5x70 mm	5
111358	Sveder mozničar 6x70 mm	6
111373	Sveder mozničar 8x70 mm	8
111364	Sveder mozničar 10x70 mm	10

- levi in desni

### Sveder mozničar

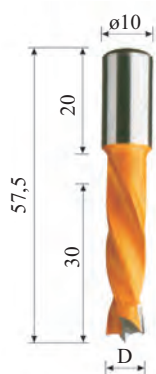

Šifra	Naziv	D (ø) mm
111356	Sveder mozničar 5x57,5 mm	5
111357	Sveder mozničar 6x57,5 mm	6
111360	Sveder mozničar 8x57,5 mm	8
111363	Sveder mozničar 10x57,5 mm	10
111365	Sveder mozničar 12x57,5 mm	12
111368	Sveder mozničar 14x57,5 mm	14

- levi in desni

### Sveder mozničar

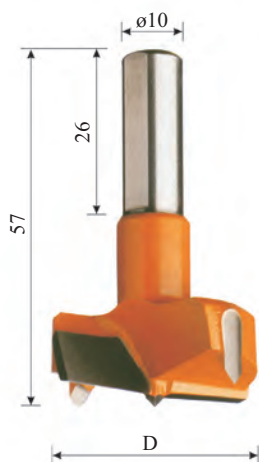

Šifra	Naziv	D (ø) mm
111417	Sveder mozničar 15x57 mm	15
111418	Sveder mozničar 16x57 mm	16
111419	Sveder mozničar 17x57 mm	17
111420	Sveder mozničar 18x57 mm	18
111421	Sveder mozničar 20x57 mm	20
111422	Sveder mozničar 22x57 mm	22
111304	Sveder mozničar 24x57 mm	24
111302	Sveder mozničar 25x57 mm	25
111424	Sveder mozničar 26x57 mm	26
111423	Sveder mozničar 28x57 mm	28
111425	Sveder mozničar 30x57 mm	30
111426	Sveder mozničar 35x57 mm	35

- levi in desni



### Sveder za les Bormax<sup>3</sup>



Šifra	Naziv	Premer (ø) mm	mm	mm	Vpetje (hex) mm
076259	1663.015.00 Bormax les HM 15 mm	15	57	90	8
111860	1663.016.00 Bormax les HM 16 mm	16	57	90	8
076261	1663.018.00 Bormax les HM 18 mm	18	57	90	8
076260	1663.020.00 Bormax les HM 20 mm	20	57	90	8
111861	1663.022.00 Bormax les HM 22 mm	22	57	90	10
076262	1663.025.00 Bormax les HM 25 mm	25	57	90	10
111862	1663.026.00 Bormax les HM 26 mm	26	57	90	10
076263	1663.030.00 Bormax les HM 30 mm	30	57	90	10
076264	1663.035.00 Bormax les HM 35 mm	35	57	90	10
076272	1663.040.00 Bormax les HM 40 mm	40	57	90	10
076273	1663.045.00 Bormax les HM 45 mm	45	57	90	10
076274	1663.050.00 Bormax les HM 50 mm	50	57	90	10

- material: zelo kvalitetna karbidna trdina glavnega rezilnega roba in rezilnih zob
- centrirna konica
- število vrtljajev: 1800-5000/min (ø 35 mm: 3000/min)
- za trd in mehak les, eksotični les, MDF, plošče, laminat, večino plastik

### Svedri za les Bormax<sup>3</sup>



Šifra	Naziv	mm	mm
111589	1663.505 Bormax les HM kpl. 15-35 mm	57	90

- komplet vsebuje:
  - 1663.015.00 Bormax les HM 15 mm
  - 1663.020.00 Bormax les HM 20 mm
  - 1663.025.00 Bormax les HM 25 mm
  - 1663.030.00 Bormax les HM 30 mm
  - 1663.035.00 Bormax les HM 35 mm
- lesena škatla
- tehnični podatki so v zgornji tabeli

### Sveder za les Bormax



Šifra	Naziv	Premer (ø) mm	mm	mm	Vpetje (hex) mm
111433	1662.015 Sveder les HM 15x90 mm	15	57	90	10
111434	1662.016 Sveder les HM 16x90 mm	16	57	90	10
111551	1662.018 Sveder les HM 18x90 mm	18	57	90	10
111552	1662.020 Sveder les HM 20x90 mm	20	57	90	10
111437	1662.022 Sveder les HM 22x90 mm	22	57	90	10
111550	1662.025 Sveder les HM 25x90 mm	25	57	90	10
111441	1662.026 Sveder les HM 26x90 mm	26	57	90	10
111443	1662.030 Sveder les HM 30x90 mm	30	57	90	10
111545	1662.035 Sveder les HM 35x90 mm	35	57	90	10
111546	1662.040 Sveder les HM 40x90 mm	40	57	90	10
111547	1662.045 Sveder les HM 45x90 mm	45	57	90	10
111548	1662.050 Sveder les HM 50x90 mm	50	57	90	10

- material: zelo kvalitetna karbidna trdina glavnega rezilnega roba, 2 rezilna zoba
- centrirna konica
- število vrtljajev: 1800-5000/min (ø 35 mm: 3000/min)
- za trd les, plastificirano iverko, plastiko



### Sveder za les Bormax



Šifra	Naziv	Premer (ø) mm	mm	mm	Vpetje (ø) mm
111570	1622.015 Sveder les 15x90 mm	15	57	90	8
111571	1622.016 Sveder les 16x90 mm	16	57	90	8
111572	1622.018 Sveder les 18x90 mm	18	57	90	8
111573	1622.020 Sveder les 20x90 mm	20	57	90	8
111569	1622.021 Sveder les 21x90 mm	21	57	90	8
111574	1622.022 Sveder les 22x90 mm	22	57	90	8
111575	1622.023 Sveder les 23x90 mm	23	57	90	8
111585	1622.024 Sveder les 24x90 mm	24	57	90	8
111576	1622.025 Sveder les 25x90 mm	25	57	90	8
111577	1622.026 Sveder les 26x90 mm	26	57	90	8
111579	1622.027 Sveder les 27x90 mm	27	57	90	8
111578	1622.028 Sveder les 28x90 mm	28	57	90	8
111582	1622.030 Sveder les 30x90 mm	30	57	90	8
111580	1622.032 Sveder les 32x90 mm	32	57	90	10
111581	1622.034 Sveder les 34x90 mm	34	57	90	10
111583	1622.035 Sveder les 35x90 mm	35	57	90	10
111586	1622.055 Sveder les 55x90 mm	55	57	90	12

- material: legirano jeklo, 2 glavna rezilna roba
- centrirna konica
- število vrtljajev: 900-3200/min (ø 35 mm: 1500/min)
- za trd in mehak les, iverne plošče, MDF

### Svedri za les Bormax



Šifra	Naziv	mm	mm
111584	1622.505 Bormax les HSS kpl. 15-35 mm		

- komplet vsebuje:
  - 1622.015 Sveder les 15x90 mm
  - 1622.020 Sveder les 20x90 mm
  - 1622.025 Sveder les 25x90 mm
  - 1622.030 Sveder les 30x90 mm
  - 1622.035 Sveder les 35x90 mm
- lesena škatla
- tehnični podatki so v zgornji tabeli

### Svedri za les Bormax



Šifra	Naziv	mm
111590	1622.508 Bormax 8 delni 15-50 mm	

- komplet vsebuje:
  - 1622.015 Sveder les 15x90 mm
  - 1622.020 Sveder les 20x90 mm
  - 1622.025 Sveder les 25x90 mm
  - 1622.030 Sveder les 30x90 mm
  - 1622.035 Sveder les 35x90 mm
  - 1622.040 Sveder les 40x90 mm
  - 1622.045 Sveder les 45x90 mm
  - 1622.050 Sveder les 50x90 mm
- lesena škatla
- tehnični podatki so v zgornji tabeli



### Svedri za les Bormax



Šifra	Naziv	mm
076000	1624.505 Svedri Bormax 15, 20, 25, 30, 35 mm	

- idealni za vrtanje pod kotom, ki ni 90°, npr. pri konstrukciji stopnišč
- centriralna konica se lahko zamenja s centrirnim svedrom
- svedri iz legiranega jekla, centrirni sveder HSS-G
- število vrtljajev: 1500-3000/min (Ø 20 mm: 2400/min)
- za trd in mehak les, MDF

**- komplet vsebuje:**

- 1624.015 Sveder les 15x90 mm
- 1624.020 Sveder les 20x90 mm
- 1624.025 Sveder les 25x90 mm
- 1624.030 Sveder les 30x90 mm
- 1624.035 Sveder les 35x90 mm
- centrirni sveder HSS-G Ø 4 x 45 mm
- MEX ključ
- imbus ključ
- lesena škatla



### Sveder za les WS

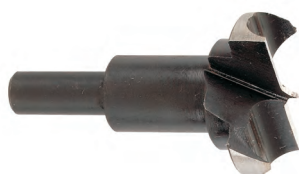

Šifra	Naziv	Premer (Ø) mm	Vpetje (Ø) mm
088671	7055-10 Sveder les WS fi 26 mm KWB	26	8
088672	7055-20 Sveder les WS fi 30 mm KWB	30	8
088673	7055-30 Sveder les WS fi 35 mm KWB	35	8

- za trd in mehak les, MDF

### Sveder za les HM

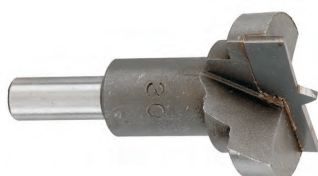

Šifra	Naziv	Premer (Ø) mm	Vpetje (Ø) mm
088670	7059-30 Sveder les HM fi 35 mm KWB	35	8

- prevlečen s tungsten-karbidom
- za trd les, prevlečene in neprevlečene iverne plošče, MDF

### Svedri za les



5 delni set

Šifra	Naziv
192334	7060-00 Svedri les DIN 7483 fi 15-35 mm KWB

- material: posebno kaljeno jeklo, kovan v skladu z DIN 7483 G
- 2 glavni rezili in 2 stranski rezili
- centriralna konica za natančen začetek vrtanja
- brez trganja lesa za čist rez
- za trd in mehak les, iverne plošče

**- komplet vsebuje:**

- svedri s premeri: Ø 15, 20, 25, 30, 35 mm
- lesena škatla



### Sveder za les po standardu DIN 7483 G



Šifra	Naziv	Premer (ø) mm	Vpetje (ø) mm
088691	7060-10 Sveder les DIN 7483 fi 10 mm KWB	10	8
088692	7060-12 Sveder les DIN 7483 fi 12 mm KWB	12	8
088694	7060-15 Sveder les DIN 7483 fi 15 mm KWB	15	8
088695	7060-16 Sveder les DIN 7483 fi 16 mm KWB	16	8
088696	7060-18 Sveder les DIN 7483 fi 18 mm KWB	18	8
088697	7060-20 Sveder les DIN 7483 fi 20 mm KWB	20	8
088698	7060-22 Sveder les DIN 7483 fi 22 mm KWB	22	8
088700	7060-25 Sveder les DIN 7483 fi 25 mm KWB	25	8
088701	7060-26 Sveder les DIN 7483 fi 26 mm KWB	26	8
088703	7060-30 Sveder les DIN 7483 fi 30 mm KWB	30	8
088705	7060-35 Sveder les DIN 7483 fi 35 mm KWB	35	10
088706	7060-40 Sveder les DIN 7483 fi 40 mm KWB	40	10
088707	7060-45 Sveder les DIN 7483 fi 45 mm KWB	45	10
088708	7060-50 Sveder les DIN 7483 fi 50 mm KWB	50	10

- material: posebno kaljeno jeklo, kovano v skladu z DIN 7483 G
- 2 glavni rezili in 2 stranski rezili
- centrirna konca za natančen začetek vrtanja
- brez trganja lesa za čist rez
- za trd in mehak les, iverne plošče

### Nastavljiv sveder za les



Šifra	Naziv	Premer (ø) mm
088337	1754-40 Sveder les 15-45x120 mm KWB	15-45

- za trd in mehak les, lahke gradbene materiale
- dve rezili: 15-25 mm, 25-40 mm
- rezilo se enostavno zamenja
- centrirna konca za natančen začetek vrtanja

### Sveder za les z grezilom



Šifra	Naziv	Premer (ø) mm
088711	5131-03 Sveder HSS z grezilom fi 3 mm KWB	3
088712	5131-04 Sveder HSS z grezilom fi 4 mm KWB	4
088713	5131-05 Sveder HSS z grezilom fi 5 mm KWB	5
088714	5131-06 Sveder HSS z grezilom fi 6 mm KWB	6

- za trd in mehak les, lahke gradbene materiale
- centrirna konca za natančen začetek vrtanja

### Sveder za les z grezilom



Šifra	Naziv	Premer (ø) mm
087892	5126-04 Sveder les HSS 4,5 mm KWB	4,5

- za trd in mehak les, lahke gradbene materiale, prevlečene in neprevlečene iverne plošče, plastiko
- material: hitrorezno jeklo HSS



**FAMAE**  
FAMAE

### Svedri za les z nastavljivim grezilom



Šifra	Naziv
111587	3575.505 Komplet 1594+2202

- material: hitrorezno jeklo HSS
- centrirna konca za natančen začetek vrtnja
- za trd in mehak les
- **komplet vsebuje:**  
svedri za les s premeri:  $\varnothing$  3, 4, 5, 6, 8 mm  
nastavljivo grezilo Vario, kot  $90^\circ$   
imbus ključ  
lesena škatla



primer sestave

### Nastavljivo grezilo



Šifra	Naziv	Zunanji ( $\varnothing$ ) mm	Notranji ( $\varnothing$ ) mm	Dolžina mm
076268	2202.000.00 Vario 3-8 mm	10,5-14,5	3-8	34

- karbidna konica
- kot:  $90^\circ$
- za vse vrste lesa, laminat, večino plastik

### Svedri za lesene terase



Šifra	Naziv
076168	3577.504 Svedri za terase 4, 5, 6 mm

- ideallno za lesene terase kjer se rabi predvrtnanje in čist ugrez glave vijaka
- material: legirano jeklo, nastavek za globino: medenina
- kot grezila:  $60^\circ$
- **komplet vsebuje:**  
svedre z grezili  $\varnothing$  4, 5, 6 mm (nastavitev globine svedra v grezilu)  
nastavek za vpetje svedra z grezilom (nastavitev globine vrtnja)  
dva imbus ključa  
lesena škatla



primer sestave

**kwb**  
WE LOVE PERFECTION.

### Sveder za lesene terase

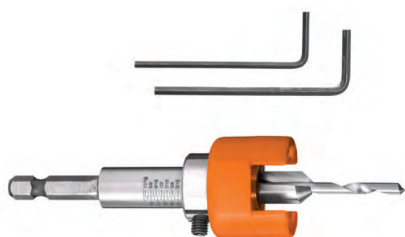

Šifra	Naziv	Premer ( $\varnothing$ ) mm	Vpetje šestrobo
192332	5120-06 Grezilo nastavljivo 6 mm	6	1/4 "

- material: hitrorezno jeklo HSS-M2
- ideallno za lesene terase kjer se rabi predvrtnanje in čist ugrez glave vijaka
- nastavljiv omejevalnik globine s krogličnim ležajem
- standard: ISO 1173
- priložena 2 imbus ključa
- za trd in mehak les



### Svedri za les



Šifra	Naziv	mm	mm
076269	1414.400.00 Svedri 460 mm 6 delni	400	460

- material: hitrorezno jeklo HSS
- centrirna konca z vijačnico za natančen začetek vrtnanja
- vpetje: šestrobno
- za trd in mehak les
- **komplet vsebuje:**  
svedri:  $\varnothing$  10, 12, 14, 16, 18, 20 mm  
lesena škatla

### Sveder za les HSS-G



Šifra	Naziv	Premer (ø) mm	mm	mm
076240	1594.030 Sveder les HSS-G 3x60 mm	3	33	60
076242	1594.040 Sveder les HSS-G 4x75 mm	4	43	75
076244	1594.050 Sveder les HSS-G 5x85 mm	5	52	85
076245	1594.060 Sveder les HSS-G 6x92 mm	6	57	92
076249	1594.080 Sveder les HSS-G 8x115 mm	8	75	115
076251	1594.090 Sveder les HSS-G 9x125 mm	9	81	125
076252	1594.100 Sveder les HSS-G 10x130 mm	10	87	130
076253	1594.120 Sveder les HSS-G 12x150 mm	12	101	150
076258	1594.130 Sveder les HSS-G 13x150 mm	13	101	150

- 2 glavna rezilna roba
- centrirna konca za natančen začetek vrtnanja
- za trd in mehak les, laminat

### Sveder za les HSS-G



Šifra	Naziv	Premer (ø) mm	mm	mm
076132	1596.030 Sveder les HSS-G 3x38 mm	3	16	38
076131	1596.040 Sveder les HSS-G 4x44 mm	4	20	44
076137	1596.050 Sveder les HSS-G 5x50 mm	5	26	50
076133	1596.060 Sveder les HSS-G 6x50 mm	6	26	50
076134	1596.070 Sveder les HSS-G 7x50 mm	7	30	50
076138	1596.080 Sveder les HSS-G 8x51 mm	8	32	51
076135	1596.090 Sveder les HSS-G 9x53 mm	9	33	53
076136	1596.100 Sveder les HSS-G 10x54 mm	10	38	54

- centrirna konca za natančen začetek vrtnanja
- vpetje: šestrobno 1/4 "
- za trd in mehak les

### Centrirni sveder



Šifra	Naziv	Premer (ø) mm	mm	mm	Vpetje šestrobo
076265	3582.030 Sveder centrirni 2,75x3 mm	2,75	14	86	1/4 "

- material: sveder HSS

### Sveder za les HSS



Šifra	Naziv	Premer (ø) mm	mm	mm
088572	0422-06 Sveder les HSS 6x230x160 KWB	6	160	230
088573	0422-08 Sveder les HSS 8x230x160 KWB	8	160	230
088574	0422-10 Sveder les HSS 10x230x160 KWB	10	160	230
088575	0422-12 Sveder les HSS 12x230x160 KWB	12	160	230
088576	0422-14 Sveder les HSS 14x230x160 KWB	14	160	230
088577	0422-16 Sveder les HSS 16x230x160 KWB	16	160	230
088578	0422-18 Sveder les HSS 18x230x160 KWB	18	160	230
088579	0422-20 Sveder les HSS 20x230x160 KWB	20	160	230
088580	0422-22 Sveder les HSS 22x230x160 KWB	22	160	230
088581	0422-24 Sveder les HSS 24x230x160 KWB	24	160	230
088582	0422-26 Sveder les HSS 26x230x160 KWB	26	160	230
088583	0422-28 Sveder les HSS 28x230x160 KWB	28	160	230
088584	0422-30 Sveder les HSS 30x230x160 KWB	30	160	230

- material: hitrorezno jeklo HSS
- centrirna konca za natančen začetek vrtnanja
- za trd in mehak les, vezane plošče
- vpetje:
  - svedri ø 6 mm: šestrobno 6 mm
  - svedri ø 8 in 10 mm: šestrobno 8 mm
  - svedri ø 12 do 30 mm: šestrobno 10 mm

### Sveder za les HSS



Šifra	Naziv	Premer (ø) mm	mm	mm
088650	0424-06 Sveder les HSS 6x460x390 KWB	6	390	460
088651	0424-08 Sveder les HSS 8x460x390 KWB	8	390	460
088648	0424-10 Sveder les HSS 10x460x390 KWB	10	390	460
088652	0424-12 Sveder les HSS 12x460x390 KWB	12	390	460
088653	0424-14 Sveder les HSS 14x460x390 KWB	14	390	460
088654	0424-16 Sveder les HSS 16x460x390 KWB	16	390	460
088655	0424-18 Sveder les HSS 18x460x390 KWB	18	390	460
088656	0424-20 Sveder les HSS 20x460x390 KWB	20	390	460
088657	0424-22 Sveder les HSS 22x460x390 KWB	22	390	460
088658	0424-24 Sveder les HSS 24x460x390 KWB	24	390	460
088659	0424-26 Sveder les HSS 26x460x390 KWB	26	390	460
088660	0424-28 Sveder les HSS 28x460x390 KWB	28	390	460
088661	0424-30 Sveder les HSS 30x460x390 KWB	30	390	460

- material: hitrorezno jeklo HSS
- centrirna konca za natančen začetek vrtnanja
- za trd in mehak les, vezane plošče
- vpetje:
  - svedri ø 6 mm: šestrobno 6 mm
  - svedri ø 8 in 10 mm: šestrobno 8 mm
  - svedri ø 12 do 30 mm: šestrobno 10 mm



### Sveder za les HSS



Šifra	Naziv	Premer (ø) mm	mm	mm
088280	5118-06 Sveder les HSS 6x250x170 mm KWB	6	185	250
088281	5118-08 Sveder les HSS 8x250x170 mm KWB	8	185	250
088282	5118-10 Sveder les HSS 10x250x170 mm KWB	10	185	250
088283	5118-12 Sveder les HSS 12x250x170 mm KWB	12	185	250
088284	5118-14 Sveder les HSS 14x250x180 mm KWB	14	185	250
088285	5118-16 Sveder les HSS 16x250x180 mm KWB	16	185	250
088286	5118-18 Sveder les HSS 18x250x180 mm KWB	18	185	250
088287	5118-20 Sveder les HSS 20x250x180 mm KWB	20	185	250
088288	5128-10 Sveder les HSS 10x400x270 mm KWB	10	285	400
088289	5128-12 Sveder les HSS 12x400x270 mm KWB	12	285	400
088290	5128-14 Sveder les HSS 14x400x270 mm KWB	14	285	400
088291	5128-16 Sveder les HSS 16x400x270 mm KWB	16	285	400
088292	5128-18 Sveder les HSS 18x400x270 mm KWB	18	285	400
088293	5128-20 Sveder les HSS 20x400x270 mm KWB	20	285	400

- material: krom-vanadium jeklo
- centrirna konca za natančen začetek vrtnanja
- za trd in mehak les

#### - vpetje:

- svedri ø 6, 8, 10 mm: premer stebila
- svedri ø 12, 14, 16 mm: ø 10 mm
- svedri ø 18, 20 mm: ø 13 mm

### Sveder za les HSS



Šifra	Naziv	Premer (ø) mm	mm
087902	5119-03 Sveder les HSS 3 mm KWB	3	61
087903	5119-04 Sveder les HSS 4 mm KWB	4	75
087904	5119-05 Sveder les HSS 5 mm KWB	5	86
087905	5119-06 Sveder les HSS 6 mm KWB	6	93
192335	5119-07 Sveder les HSS 7 mm KWB	7	109
087906	5119-08 Sveder les HSS 8 mm KWB	8	117
192336	5119-09 Sveder les HSS 9 mm KWB	9	125
087907	5119-10 Sveder les HSS 10 mm KWB	10	133

- prihranek energije in časa 30 %
- material: hitrorezno jeklo HSS-M2
- centrirna konca za natančen začetek vrtnanja
- 2 x hitrejša vrtnanja v trd les kot z običajnimi svedri za les
- izredno ostri polirani robovi
- industrijska kakovost
- za trd in mehak les, iverne plošče, mavčne plošče, plastiko



### Sveder za les krom-vanadium



Šifra	Naziv	Premer (Ø) mm	Vpetje (Ø) mm
088273	5114-63 Sveder les 3 mm KWB	3	3
088274	5114-64 Sveder les 4 mm KWB	4	4
088275	5114-65 Sveder les 5 mm KWB	5	5
088163	5114-66 Sveder les 6 mm KWB	6	6
088164	5114-68 Sveder les 8 mm KWB	8	8
088276	5114-70 Sveder les 10 mm KWB	10	10
088277	5114-72 Sveder les 12 mm KWB	12	8
088278	5114-74 Sveder les 14 mm KWB	14	10
088279	5114-76 Sveder les 16 mm KWB	16	10

- material: krom-vanadium
- centrirna konca za natančen začetek vrtnja

### Svedri za les krom-vanadium



5 delni set

Šifra	Naziv
087947	5140-00 Svedri les 4-10 mm 5 delni KWB

- material: krom-vanadium
- centrirna konca za natančen začetek vrtnja
- 2 rezilni spirali
- industrijska kakovost
- za trd in mehak les
- **komplet vsebuje:**  
svedri s premeri: Ø 4, 5, 6, 8, 10 mm  
PVC kasete za svedre

### Svedri za les krom-vanadium po standardu ISO 1173



5 delni set

Šifra	Naziv
192269	5139-00 Sveder za les 5 delni 1/4" KWB

- material: krom-vanadium
- vpetje: šeststrobo 1/4 "
- centrirna konica za natančen začetek vrtnja
- 2 rezilni spirali
- za mehak in trd les
- **komplet vsebuje:**  
svedri s premeri: Ø 3, 4, 5, 6, 8 mm  
PVC kasete za svedre



### Svedri za les krom-vanadium



8 delni set

Šifra	Naziv
-------	-------

088069	5141-00 Svedri les 3-10 mm 8 delni KWB
--------	--

- material: krom-vanadium
- centrirna konca za natančen začetek vrtnanja
- za trd in mehak les
- **komplet vsebuje:**  
svedri s premeri: ø 3, 4, 5, 6, 7, 8, 9, 10 mm  
PVC kasetna za svedre



### Sveder za kovino HSS po standardu DIN 338



19 delni set

Šifra	Naziv	Premer (ø) mm	mm	mm
155200	4932 3523 45 Sveder HSS-G 1,0x34 mm	1,0	12	34
155201	4932 3523 46 Sveder HSS-G 1,5x40 mm	1,5	18	40
155202	4932 3523 47 Sveder HSS-G 2,0x49 mm	2,0	24	49
155203	4932 3523 48 Sveder HSS-G 2,5x57 mm	2,5	30	57
155204	4932 3523 49 Sveder HSS-G 3,0x61 mm	3,0	33	61
155205	4932 3523 50 Sveder HSS-G 3,2x65 mm	3,2	36	65
155206	4932 3523 51 Sveder HSS-G 3,5x70 mm	3,5	39	70
155207	4932 3523 52 Sveder HSS-G 4,0x75 mm	4,0	43	75
155208	4932 3523 53 Sveder HSS-G 4,2x75 mm	4,2	47	75
155209	4932 3523 54 Sveder HSS-G 4,5x80 mm	4,5	47	80
155227	4932 3523 55 Sveder HSS-G 4,8x86 mm	4,8	52	86
155210	4932 3523 56 Sveder HSS-G 5,0x86 mm	5,0	52	86
155211	4932 3523 57 Sveder HSS-G 5,5x93 mm	5,5	57	93
155212	4932 3523 58 Sveder HSS-G 6,0x93 mm	6,0	57	93
155213	4932 3523 59 Sveder HSS-G 6,5x101 mm	6,5	63	101
155214	4932 3523 09 Sveder HSS-G 6,8x109 mm	6,8	69	109
155215	4932 3523 61 Sveder HSS-G 7,0x109 mm	7,0	69	109
155216	4932 3523 62 Sveder HSS-G 7,5x109 mm	7,5	69	109
155217	4932 3523 63 Sveder HSS-G 8,0x117 mm	8,0	75	117
155218	4932 3523 64 Sveder HSS-G 8,5x117 mm	8,5	75	117
155219	4932 3523 65 Sveder HSS-G 9,0x125 mm	9,0	81	125
155228	4932 3523 66 Sveder HSS-G 9,5x125 mm	9,5	81	125
155220	4932 3523 67 Sveder HSS-G 10,0x133 mm	10,0	87	133
155221	4932 3523 68 Sveder HSS-G 10,5x133 mm	10,5	87	133
155222	4932 3523 69 Sveder HSS-G 11,0x142 mm	11,0	94	142
155223	4932 3523 70 Sveder HSS-G 11,5x142 mm	11,5	94	142
155224	4932 3523 71 Sveder HSS-G 12,0x151 mm	12,0	101	151
155225	4932 3523 72 Sveder HSS-G 12,5x151 mm	12,5	101	151
155226	4932 3523 73 Sveder HSS-G 13,0x151 mm	13,0	101	151
151654	4932 3523 74 HSS-G Set svedrov za kovino			

- za lažje delo in večji navor
- boljše odvajanje toplote podaljšuje življenjsko dobo
- natančen začetek vrtnanja brez spodletavanja svedra
- za vrtnanje tudi na ukrivljenih površinah
- posebej primeren za vrtnanje v trde materiale
- veliko manj lomljenja svedra
- odlično odvajanje ostružkov
- ostri robovi

**- 19 delni set vsebuje svedre:**

ø: 1,0 1,5 2,0 2,5 3,0 3,5 4,0 4,5 5,0 5,5 6,0 6,5 7,0 7,5 8,0 8,5 9,0 9,5 10,0 mm



### Sveder za kovino HSS-G po standardu DIN 340



Šifra	Naziv	Premer (ø) mm	mm	mm
076122	2450.030 Sveder HSS-G 3 mm DIN 340	3,0	66	100
076100	2450.032 Sveder HSS-G 3,2 mm DIN 340	3,2	69	106
076123	2450.035 Sveder HSS-G 3,5 mm DIN 340	3,5	73	112
076124	2450.040 Sveder HSS-G 4 mm DIN 340	4,0	78	119
076125	2450.045 Sveder HSS-G 4,5 mm DIN 340	4,5	82	126
076101	2450.050 Sveder HSS-G 5 mm DIN 340	5,0	87	132
076127	2450.060 Sveder HSS-G 6 mm DIN 340	6,0	91	139
076128	2450.065 Sveder HSS-G 6,5 mm DIN 340	6,5	97	148
076102	2450.080 Sveder HSS-G 8 mm DIN 340	8,0	109	165

- material: hitrorezno jeklo HSS

### Svedri za kovino HSS-G po standardu DIN 338



19 delni set

Šifra	Naziv
076276	2411.519 Svedri HSS-G 1-10 mm 19 delni

- za najvišje zahteve v industriji in obrti
- material: hitrorezno jeklo HSS-G
- za legirano in nelegirano jeklo, lito jeklo do 900 NMM, mehko železo, sintrano železo, nesintrano železo, neželezne kovine, nikelj srebro, grafit, trdo plastiko
- toleranca premera: h8
- polirana ovojnica
- svetli
- **komplet vsebuje:**  
svedri s premeri: ø 1,0 1,5 2,0 2,5 3,0 3,5 4,0 4,5 5,0 5,5 6,0 6,5 7,0 7,5 8,0 8,5 9,0 9,5 10,0 mm  
PVC kasetta za svedre



### Svedri za kovino HSS-G po standardu DIN 338



25 delni set

Šifra	Naziv
076277	2411.525 Svedri HSS-G 1-13 mm 25 delni

- za najvišje zahteve v industriji in obrti
- material: hitrorezno jeklo HSS-G
- za legirano in nelegirano jeklo, lito jeklo do 900 NMM, mehko železo, sintrano železo, nesintrano železo, neželezne kovine, nikelj srebro, grafit, trdo plastiko
- toleranca premera: h8
- polirana ovojnica
- svetli
- **komplet vsebuje:**  
svedri s premeri: ø 1,0 1,5 2,0 2,5 3,0 3,5 4,0 4,5 5,0 5,5 6,0 6,5 7,0 7,5 8,0 8,5 9,0 9,5 10,0 10,5 11,0 11,5 12,0 12,5 13,0 mm  
PVC kasetta za svedre







### Sveder za kovino HSS po standardu DIN 338



Šifra	Naziv	Premer (ø) mm	Pakirano kos
097005	205-010 Sveder HSS 1,0 mm STAR	1,0	10
097006	205-011 Sveder HSS 1,1 mm STAR	1,1	10
097007	205-012 Sveder HSS 1,2 mm STAR	1,2	10
097008	205-013 Sveder HSS 1,3 mm STAR	1,3	10
097009	205-014 Sveder HSS 1,4 mm STAR	1,4	10
097010	205-015 Sveder HSS 1,5 mm STAR	1,5	10
097011	205-016 Sveder HSS 1,6 mm STAR	1,6	10
097012	205-017 Sveder HSS 1,7 mm STAR	1,7	10
097013	205-018 Sveder HSS 1,8 mm STAR	1,8	10
097014	205-019 Sveder HSS 1,9 mm STAR	1,9	10
097015	205-020 Sveder HSS 2,0 mm STAR	2,0	10
097016	205-021 Sveder HSS 2,1 mm STAR	2,1	10
097017	205-022 Sveder HSS 2,2 mm STAR	2,2	10
097018	205-023 Sveder HSS 2,3 mm STAR	2,3	10
097019	205-024 Sveder HSS 2,4 mm STAR	2,4	10
097020	205-025 Sveder HSS 2,5 mm STAR	2,5	10
097021	205-026 Sveder HSS 2,6 mm STAR	2,6	10
097022	205-027 Sveder HSS 2,7 mm STAR	2,7	10
097023	205-028 Sveder HSS 2,8 mm STAR	2,8	10
097024	205-029 Sveder HSS 2,9 mm STAR	2,9	10
097025	205-030 Sveder HSS 3,0 mm STAR	3,0	10
097026	205-031 Sveder HSS 3,1 mm STAR	3,1	10
088058	205-032 Sveder HSS 3,2 mm STAR	3,2	10
097027	205-033 Sveder HSS 3,3 mm STAR	3,3	10
097028	205-034 Sveder HSS 3,4 mm STAR	3,4	10
097029	205-035 Sveder HSS 3,5 mm STAR	3,5	10
097030	205-036 Sveder HSS 3,6 mm STAR	3,6	10
097031	205-037 Sveder HSS 3,7 mm STAR	3,7	10
097032	205-038 Sveder HSS 3,8 mm STAR	3,8	10
097033	205-039 Sveder HSS 3,9 mm STAR	3,9	10
097034	205-040 Sveder HSS 4,0 mm STAR	4,0	10
097035	205-041 Sveder HSS 4,1 mm STAR	4,1	10
097036	205-042 Sveder HSS 4,2 mm STAR	4,2	10
097037	205-043 Sveder HSS 4,3 mm STAR	4,3	10
097038	205-044 Sveder HSS 4,4 mm STAR	4,4	10
097039	205-045 Sveder HSS 4,5 mm STAR	4,5	10
097040	205-046 Sveder HSS 4,6 mm STAR	4,6	10
097041	205-047 Sveder HSS 4,7 mm STAR	4,7	10
097042	205-048 Sveder HSS 4,8 mm STAR	4,8	10
097043	205-049 Sveder HSS 4,9 mm STAR	4,9	10

- material: hitrorezno jeklo HSS
- za legirano in nelegirano jeklo, lito jeklo, železo, sintrano železo, profile, pločevino, neželezne kovine, plastiko



### Sveder za kovino HSS po standardu DIN 338



Šifra	Naziv	Premer (Ø) mm
097044	205-050 Sveder HSS 5,0 mm STAR	5,0
097045	205-051 Sveder HSS 5,1 mm STAR	5,1
097046	205-052 Sveder HSS 5,2 mm STAR	5,2
097047	205-053 Sveder HSS 5,3 mm STAR	5,3
097048	205-054 Sveder HSS 5,4 mm STAR	5,4
097049	205-055 Sveder HSS 5,5 mm STAR	5,5
097050	205-056 Sveder HSS 5,6 mm STAR	5,6
097051	205-057 Sveder HSS 5,7 mm STAR	5,7
097052	205-058 Sveder HSS 5,8 mm STAR	5,8
097053	205-059 Sveder HSS 5,9 mm STAR	5,9
088059	205-060 Sveder HSS 6,0 mm STAR	6,0
097054	205-061 Sveder HSS 6,1 mm STAR	6,1
097055	205-062 Sveder HSS 6,2 mm STAR	6,2
097056	205-063 Sveder HSS 6,3 mm STAR	6,3
097057	205-064 Sveder HSS 6,4 mm STAR	6,4
097058	205-065 Sveder HSS 6,5 mm STAR	6,5
097059	205-066 Sveder HSS 6,6 mm STAR	6,6
097060	205-067 Sveder HSS 6,7 mm STAR	6,7
097061	205-068 Sveder HSS 6,8 mm STAR	6,8
097062	205-069 Sveder HSS 6,9 mm STAR	6,9
097063	205-070 Sveder HSS 7,0 mm STAR	7,0
097064	205-071 Sveder HSS 7,1 mm STAR	7,1
097065	205-072 Sveder HSS 7,2 mm STAR	7,2
097066	205-073 Sveder HSS 7,3 mm STAR	7,3
097067	205-074 Sveder HSS 7,4 mm STAR	7,4
097068	205-075 Sveder HSS 7,5 mm STAR	7,5
097069	205-076 Sveder HSS 7,6 mm STAR	7,6
097070	205-077 Sveder HSS 7,7 mm STAR	7,7
097071	205-078 Sveder HSS 7,8 mm STAR	7,8
097072	205-079 Sveder HSS 7,9 mm STAR	7,9
097073	205-080 Sveder HSS 8,0 mm STAR	8,0
097074	205-081 Sveder HSS 8,1 mm STAR	8,1
097075	205-082 Sveder HSS 8,2 mm STAR	8,2
097076	205-083 Sveder HSS 8,3 mm STAR	8,3
097077	205-084 Sveder HSS 8,4 mm STAR	8,4
097078	205-085 Sveder HSS 8,5 mm STAR	8,5
097079	205-086 Sveder HSS 8,6 mm STAR	8,6
097080	205-087 Sveder HSS 8,7 mm STAR	8,7
097081	205-088 Sveder HSS 8,8 mm STAR	8,8
097082	205-089 Sveder HSS 8,9 mm STAR	8,9

- material: hitrežno jeklo HSS
- za legirano in nelegirano jeklo, lito jeklo, železo, sintrano železo, profile, pločvino, neželezne kovine, plastiko
- pakirano: 10 kos



### Sveder za kovino HSS po standardu DIN 338



Šifra	Naziv	Premer (ø) mm
097083	205-090 Sveder HSS 9,0 mm STAR	9,0
097084	205-091 Sveder HSS 9,1 mm STAR	9,1
097085	205-092 Sveder HSS 9,2 mm STAR	9,2
097086	205-093 Sveder HSS 9,3 mm STAR	9,3
097087	205-094 Sveder HSS 9,4 mm STAR	9,4
097088	205-095 Sveder HSS 9,5 mm STAR	9,5
097089	205-096 Sveder HSS 9,6 mm STAR	9,6
097090	205-097 Sveder HSS 9,7 mm STAR	9,7
097091	205-098 Sveder HSS 9,8 mm STAR	9,8
097092	205-099 Sveder HSS 9,9 mm STAR	9,9
097093	205-100 Sveder HSS 10,0 mm STAR	10,0
097094	205-105 Sveder HSS 10,5 mm STAR	10,5
097095	205-110 Sveder HSS 11,0 mm STAR	11,0
097096	205-115 Sveder HSS 11,5 mm STAR	11,5
097097	205-120 Sveder HSS 12,0 mm STAR	12,0
097098	205-125 Sveder HSS 12,5 mm STAR	12,5
097099	205-130 Sveder HSS 13,0 mm STAR	13,0

- material: hitrorežno jeklo HSS
- za legirano in nelegirano jeklo, lito jeklo, železo, sintrano železo, profile, pločevino, neželezne kovine, plastiko
- pakirano: 10 kos

### Sveder za kovino HSS po standardu DIN 340



Šifra	Naziv	Premer (ø) mm	mm	mm
097100	217-030 Sveder HSS 3,0x100 mm KWB	3,0	100	65
097101	217-032 Sveder HSS 3,2x106 mm KWB	3,2	106	70
097103	217-035 Sveder HSS 3,5x112 mm KWB	3,5	112	75
097104	217-040 Sveder HSS 4,0x119 mm KWB	4,0	119	78
097105	217-042 Sveder HSS 4,2x119 mm KWB	4,2	119	78
097106	217-045 Sveder HSS 4,5x126 mm KWB	4,5	126	80
097107	217-050 Sveder HSS 5,0x132 mm KWB	5,0	132	85
097108	217-055 Sveder HSS 5,5x139 mm KWB	5,5	139	90
097109	217-060 Sveder HSS 6,0x139 mm KWB	6,0	139	90
097110	217-065 Sveder HSS 6,5x149 mm KWB	6,5	149	95
097111	217-070 Sveder HSS 7,0x156 mm KWB	7,0	156	100
097112	217-075 Sveder HSS 7,5x156 mm KWB	7,5	156	100
097113	217-080 Sveder HSS 8,0x165 mm KWB	8,0	165	110
097114	217-085 Sveder HSS 8,5x165 mm KWB	8,5	165	110
097115	217-090 Sveder HSS 9,0x175 mm KWB	9,0	175	115
097116	217-095 Sveder HSS 9,5x175 mm KWB	9,5	175	115
097117	217-100 Sveder HSS 10,0x194 mm KWB	10,0	194	120

- material: hitrorežno jeklo HSS
- za legirano in nelegirano jeklo, lito jeklo, mehko železo, sintrano železo, neželezne kovine, plastiko



### Sveder za kovino HSS po standardu DIN 338



Šifra	Naziv	Premer (ø) mm	mm	mm
192326	4211-02 Sveder HSS Z 1/4" 2 mm	2,0	15	21
192327	4211-03 Sveder HSS Z 1/4" 3 mm	3,0	15	21
192328	4211-04 Sveder HSS Z 1/4" 4 mm	4,0	20	28
192329	4211-05 Sveder HSS Z 1/4" 5 mm	5,0	25	34
192330	4211-06 Sveder HSS Z 1/4" 6 mm	6,0	27	34

- material: hitrorezno jeklo HSS
- vpetje: šestrobno 1/4"
- za legirano in nelegirano jeklo, jeklene litine, sintrano železo, neželezne kovine, trdo plastiko

### Svedri za kovino HSS



5 delni set

Šifra	Naziv
192325	2055-20 Svedri HSS 6 delni profi KWB

- material: hitrorezno jeklo HSS
- vpetje: šestrobno 1/4"
- za legirano in nelegirano jeklo, jeklene litine, sintrano železo, neželezne kovine, trdo plastiko
- standard: ISO 1173
- **komplet vsebuje:**  
svedri s premeri: ø 2,0 3,0 4,0 5,0 6,0 mm  
kasetna za svedre



### Svedri za kovino HSS po standardu DIN 338



6 delni set

Šifra	Naziv
192325	2055-20 Svedri HSS 6 delni profi KWB

- material: hitrorezno jeklo HSS
- za legirano in nelegirano jeklo, jeklene litine, sintrano železo, neželezne kovine, trdo plastiko
- industrijska kakovost
- **komplet vsebuje:**  
svedri s premeri: ø 2,0 3,0 4,0 5,0 6,0 8,0 mm  
kasetna za svedre





### Svedri za kovino HSS po standardu DIN 338



13 delni set

Šifra	Naziv
192324	2058-40 Svedri HSS 13 delni profi KWB

- material: hitrorežno jeklo HSS
- za legirano in nelegirano jeklo, jeklene litine, sintrano železo, neželezne kovine, trdo plastiko
- industrijska kakovost
- **komplet vsebuje:**  
svedri s premeri:  $\varnothing$  1,5 2,0 2,5 3,0 3,3 3,5 4,0 4,2 4,5 5,0 5,5 6,0 6,5 mm  
kasete za svedre



### Svedri za kovino HSS po standardu DIN 338



19 delni set

Šifra	Naziv
088060	2059-20 Svedri HSS 19 delni profi KWB

- material: hitrorežno jeklo HSS
- za legirano in nelegirano jeklo, lito jeklo, mehko železo, sintrano železo, neželezne kovine, trdo plastiko
- industrijska kakovost
- **komplet vsebuje:**  
svedri s premeri:  $\varnothing$  1,0 1,5 2,0 2,5 3,0 3,5 4,0 4,5 5,0 5,5 6,0 6,5 7,0 7,5 8,0 8,5 9,0 9,5 10,0 mm  
kasete za svedre



### Svedri za kovino HSS po standardu DIN 338



19 delni set

Šifra	Naziv
088066	4219-20 Svedri HSS 19 delni KWB

- material: hitrorežno jeklo HSS
- za legirano in nelegirano jeklo, lito jeklo, mehko železo, neželezne kovine, trdo plastiko
- **komplet vsebuje:**  
svedri s premeri:  $\varnothing$  1,0 1,5 2,0 2,5 3,0 3,5 4,0 4,5 5,0 5,5 6,0 6,5 7,0 7,5 8,0 8,5 9,0 9,5 10,0 mm  
kasete za svedre





### Svedri za kovino HSS po standardu DIN 338



19 delni set

Šifra Naziv

**088065** 4218-20 Svedri HSS titan 19 delni KWB

- material: hitrorezno jeklo HSS
- za legirano in nelegirano jeklo, jeklene litine, sintrano železo, neželezne kovine, trdo plastiko
- prevlečeni s titan nitridom, industrijska kakovost
- **komplet vsebuje:**  
svedri s premeri:  $\varnothing$  1,0 1,5 2,0 2,5 3,0 3,5 4,0 4,5 5,0 5,5 6,0 6,5 7,0 7,5 8,0 8,5 9,0 9,5 10,0 mm
- kaseta za svedre



### Svedri za kovino HSS po standardu DIN 338



19 delni set

Šifra Naziv

**088687** 2489-20 Sveder HSS-CO DIN 338 1-10 mm KWB

- material: hitrorezno jeklo HSS
- visoka temperaturna odpornost
- za legirano in nelegirano jeklo, nerjaveče jeklo V2A/V4A, lito jeklo, lito železo, bron, trdo plastiko
- dodano 5 % kobalta
- industrijska kakovost
- **komplet vsebuje:**  
svedri s premeri:  $\varnothing$  1,0 1,5 2,0 2,5 3,0 3,5 4,0 4,5 5,0 5,5 6,0 6,5 7,0 7,5 8,0 8,5 9,0 9,5 10,0 mm
- kaseta za svedre



### Svedri za kovino HSS po standardu DIN 338



25 delni set

Šifra Naziv

**192323** 2057-20 Svedri HSS 25 delni profi KWB

- material: hitrorezno jeklo HSS
- za legirano in nelegirano jeklo, jeklene litine, sintrano železo, neželezne kovine, trdo plastiko
- industrijska kakovost
- **komplet vsebuje:**  
svedri s premeri:  $\varnothing$  1,0 1,5 2,0 2,5 3,0 3,5 4,0 4,5 5,0 5,5 6,0 6,5 7,0 7,5 8,0 8,5 9,0 9,5 10,0 10,5 11,0 11,5 12,0 12,5 13,0 mm
- kaseta za svedre





### Koničasti sveder



Šifra	Naziv
-------	-------

097254	5258-30 Koničasti sveder 6-30 mm
--------	----------------------------------

- material: hitrorežno jeklo HSS
- velikost: 6-30 mm
- korak: 2 mm
- centrirna konca za natančen začetek vrtnja
- za tanke materiale (jeklene kovine, neželezne kovine, plastika)



### Sveder SDS-Plus - 4 rezila

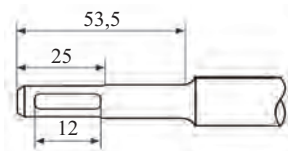

7 delni set

Šifra	Naziv	Premer (ø) mm	mm	mm
155030	4932 3520 07 SDS sveder 5x110/50 mm 4 cut	5	50	110
155031	4932 3520 08 SDS sveder 5x160/100 mm 4 cut	5	100	160
155032	4932 3520 11 SDS sveder 6x110/50 mm 4 cut	6	50	110
155033	4932 3520 12 SDS sveder 6x160/100 mm 4 cut	6	100	160
155034	4932 3520 13 SDS sveder 6x210/150 mm 4 cut	6	150	210
155035	4932 3520 14 SDS sveder 6x260/200 mm 4 cut	6	200	260
155036	4932 3520 15 SDS sveder 6x310/250 mm 4 cut	6	250	310
155037	4932 3520 16 SDS sveder 6,5x210/150 mm 4 cut	6,5	150	210
155038	4932 3520 17 SDS sveder 6,5x260/200 mm 4 cut	6,5	200	260
155039	4932 3520 18 SDS sveder 6,5x310/250 mm 4 cut	6,5	250	310
155040	4932 3520 21 SDS sveder 8x110/50 mm 4 cut	8	50	110
155041	4932 3520 22 SDS sveder 8x160/100 mm 4 cut	8	100	160
155042	4932 3520 23 SDS sveder 8x210/150 mm 4 cut	8	150	210
155043	4932 3520 24 SDS sveder 8x260/200 mm 4 cut	8	200	260
155044	4932 3520 26 SDS sveder 10x160/100 mm 4 cut	10	100	160
155045	4932 3520 27 SDS sveder 10x210/150 mm 4 cut	10	150	210
155046	4932 3520 28 SDS sveder 10x260/200 mm 4 cut	10	200	260
155047	4932 3520 29 SDS sveder 10x310/250 mm 4 cut	10	250	310
155048	4932 3520 31 SDS sveder 12x160/100 mm 4 cut	12	100	160
155049	4932 3520 32 SDS sveder 12x210/150 mm 4 cut	12	150	210
155050	4932 3520 33 SDS sveder 12x260/200 mm 4 cut	12	200	260
155051	4932 3520 34 SDS sveder 12x310/250 mm 4 cut	12	250	310
155105	4932 3520 51 Svedri SDS-plus RX4 7 delni			

#### - enostavno centriranje

posebno oblikovana konica zagotavlja natančno pozicioniranje in preprečuje zdrs svedra na trdih in gladkih materialih

#### - optimalno odstranjevanje prahu

globoki utori spirale zagotavljajo hitro odvajanje prahu iz izvrtine za manjšo obrabo konice in s tem večjo zmogljivost ter daljšo življenjsko dobo svedra

#### - natančne okrogle izvrtine

zahvaljujoč dvema dodatnima karbidnima reziloma sveder zagotavlja natančne okrogle izvrtine in odlično zmogljivost tudi ob morebitnem vrtnanju jeklene armature betona

#### - velik prenos moči

vijačnica zagotavlja najboljši možen prenos moči z vpetja na konico svedra ter najmanjše možne vibracije

#### - vrtnanje v beton, armiran beton, opeko, naravni kamen

#### - 7 delni set vsebuje svedre:

ø 5/6/8 x 100 mm

ø 6/8/10/12 x 160 mm





### Sveder SDS-Plus

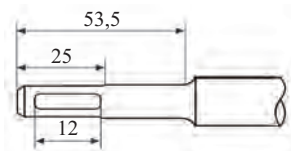

Šifra	Naziv	Premer (ø) mm	mm	mm
154950	4932 3394 98 SDS Sveder 4x110/50 mm	4	50	110
154951	4932 3991 43 SDS Sveder 4x160/100 mm	4	100	160
154952	4932 3070 67 SDS Sveder 5x110/50 mm	5	50	110
154953	4932 3993 15 SDS Sveder 5x160/100 mm	5	100	160
154954	4932 3993 16 SDS Sveder 5x210/150 mm	5	150	210
154955	4932 3070 68 SDS Sveder 6x110/50 mm	6	50	110
155000	4932 3070 69 SDS Sveder 6x160/100 mm	6	100	160
155001	4932 3731 36 SDS Sveder 6x210/150 mm	6	150	210
155002	4932 3538 19 SDS Sveder 6x260/200 mm	6	200	260
071763	4932 3993 21 SDS Sveder 6x310/250 mm	6	250	310
154957	4932 3993 22 SDS Sveder 6x460/400 mm	6	400	460
155014	4932 3442 92 SDS Sveder 6,5x110/50 mm	6,5	50	110
155015	4932 3442 93 SDS Sveder 6,5x160/100 mm	6,5	100	160
155016	4932 3991 47 SDS Sveder 6,5x210/150 mm	6,5	150	210
155017	4932 3991 48 SDS Sveder 6,5x260/200 mm	6,5	200	260
071793	4932 3993 23 SDS Sveder 6,5x310/260 mm	6,5	260	310
154956	4932 3070 70 SDS Sveder 8x110/50 mm	8	50	110
155003	4932 3070 71 SDS Sveder 8x160/100 mm	8	100	160
155004	4932 3070 72 SDS Sveder 8x210/150 mm	8	150	210
155005	4932 3538 21 SDS Sveder 8x260/200 mm	8	200	260
154958	4932 3993 25 SDS Sveder 8x310/250 mm	8	250	310
154959	4932 3993 26 SDS Sveder 8x400/350 mm	8	350	400
154960	4932 3670 13 SDS Sveder 8x460/400 mm	8	400	460
154961	4932 3404 10 SDS Sveder 10x110/50 mm	10	50	110
155006	4932 3070 73 SDS Sveder 10x160/100 mm	10	100	160
155007	4932 3070 74 SDS Sveder 10x210/150 mm	10	150	210
155008	4932 3442 95 SDS Sveder 10x260/200 mm	10	200	260
154962	4932 3538 24 SDS Sveder 10x310/250 mm	10	250	310
154963	4932 3442 96 SDS Sveder 10x450/400 mm	10	400	450
155010	4932 3070 76 SDS Sveder 12x210/150 mm	12	150	210
155011	4932 3442 97 SDS Sveder 12x260/200 mm	12	200	260
155012	4932 3538 25 SDS Sveder 12x310/250 mm	12	250	310
155013	4932 3070 77 SDS Sveder 12x450/400 mm	12	400	450
154964	4932 3070 78 SDS Sveder 14x160/100 mm	14	100	160
154965	4932 3538 26 SDS Sveder 14x210/150mm	14	150	210
154966	4932 3070 79 SDS Sveder 14x260/200 mm	14	200	260
154967	4932 3993 30 SDS Sveder 14x310/250 mm	14	250	310

- **največja hitrost vrtnja:** dinamična glava svedra v obliki dleta zagotavlja hiter prodor in optimalen odrez materiala
- **največja trajnost:** najtrša ter globoko in zanesljivo pilotana karbidna konica izpopolnjene oblike zagotavlja neprimerljivo trajnost tudi pri obdelavi armiranega betona
- **minimalne vibracije:** edinstvena zasnova s 4 vijačnicami zmanjša vibracije in omogoča prenos energije neposredno na konico svedra



### Sveder SDS-Plus

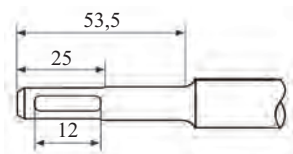

Šifra	Naziv	Premer (ø) mm	mm	mm
154968	4932 3070 80 SDS Sveder 16x160/100 mm	16	100	160
154969	4932 3070 81 SDS Sveder 16x210/150 mm	16	150	210
154970	4932 3993 31 SDS Sveder 16x260/200 mm	16	200	260
154971	4932 3443 01 SDS Sveder 16x310/250 mm	16	250	310
154972	4932 3443 03 SDS Sveder 18x200/150 mm	18	150	200
154973	4932 3070 83 SDS Sveder 18x250/200 mm	18	200	250
154974	4932 3443 04 SDS Sveder 18x300/250 mm	18	250	300
154975	4932 3404 11 SDS Sveder 18x450/400 mm	18	400	450
154976	4932 3070 84 SDS Sveder 20x250/200 mm	20	200	250
154977	4932 3990 27 SDS Sveder 20x300/250 mm	20	250	300
154978	4932 3070 85 SDS Sveder 20x450/400 mm	20	400	450
154979	4932 3739 11 SDS Sveder 22x250/200 mm	22	200	250
154980	4932 3443 07 SDS Sveder 22x450/400 mm	22	400	450
154981	4932 3670 27 SDS Sveder 22x600/550 mm	22	550	600
154982	4932 3739 22 SDS Sveder 24x250/200 mm	24	200	250
154983	4932 3070 87 SDS Sveder 24x450/400 mm	24	400	450

- **največja hitrost vrtnja:** dinamična glava svedra v obliki dleta zagotavlja hiter prodor in optimalen odrez materiala
- **največja trajnost:** najtrša ter globoko in zanesljivo prilotana karbidna konica izpopolnjene oblike zagotavlja veliko trajnost tudi pri obdelavi armiranega betona
- **minimalne vibracije:** edinstvena zasnova s 4 vijačnicami zmanjša vibracije in omogoča prenos energije neposredno na konico svedra



### Sveder SDS-Plus

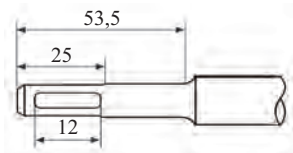

Šifra	Naziv	Premer (ø) mm	mm	mm
155879	Sveder SDS Plus 2 rez. fi6 110/50 pak10	6	50	110
155880	Sveder SDS Plus 2 rez. fi6 160/100 pak10	6	100	160
155881	Sveder SDS Plus 2 rez. fi8 110/50 pak10	8	50	110
155882	Sveder SDS Plus 2 rez. fi8 160/100 pak10	8	100	160
155883	Sveder SDS Plus 2 rez. fi8 210/150 pak10	8	150	210
155884	Sveder SDS Plus 2 rez. fi10 160/100 pak10	10	100	160
155885	Sveder SDS Plus 2 rez. fi10 210/150 pak10	10	150	210
155885	Sveder SDS Plus 2 rez. fi10 210/150 pak10	10	150	210
155886	Sveder SDS Plus 2 rez. fi10 260/200 pak10	10	200	260
155887	Sveder SDS Plus 2 rez. fi12 160/100 pak10	12	100	160
155889	Sveder SDS Plus 2 rez. fi12 210/150 pak10	12	150	210

- zelo kakovosten sveder z dvema rezili s kotom 130°
- karbidna trdina je vstavljena globlje v glavo za bolj natančno prileganje in izboljšano trajnost
- geometrija 2 žlebov za hitro in učinkovito odstranjevanje materiala
- površinsko obdelan žleb preprečuje vezavo materiala za hitrejše vrtnje in povečuje obrabno trdnost

AEG POWERTOOLS

### Sveder SDS-Max

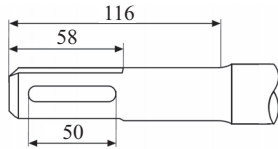

Šifra	Naziv	Premer (ø) mm	mm	mm
155890	Sveder SDS-Max 2 rez. fi16 540/400	16	400	540
155891	Sveder SDS-Max 2 rez. fi18 540/400	18	400	540
155892	Sveder SDS-Max 2 rez. fi20 520/400	20	400	520
155893	Sveder SDS-Max 2 rez. fi22 520/400	22	400	520
155894	Sveder SDS-Max 2 rez. fi25 520/400	25	400	520
155895	Sveder SDS-Max 2 rez. fi28 570/450	28	450	570
155896	Sveder SDS-Max 2 rez. fi30 570/450	30	450	570
155897	Sveder SDS-Max 2 rez. fi32 570/450	32	450	570

- zelo kakovosten sveder z dvema rezili
- geometrija 2 žlebov za hitro in učinkovito odstranjevanje materiala
- površinsko obdelan žleb preprečuje vezavo materiala za hitrejše vrtnanje in povečuje obrabno trdnost



### Dleto SDS-Plus koničasto



Šifra	Naziv	mm
155351	4932 3437 35 SDS Konica 400 mm	400

### Dleto SDS-Plus ravno



Šifra	Naziv	Širina mm	mm
155353	4932 3437 38 SDS Dleto 25x400 mm	25	400

### Dleto SDS-Plus z lopatko



Šifra	Naziv	Širina mm	mm
155352	4932 3437 43 SDS Dleto 50x400 mm	50	400



### Svedri in dleta SDS-Plus



6 delni set

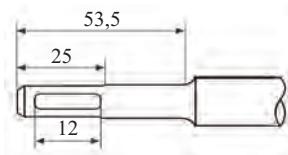

Šifra	Naziv
192315	1091-66 Set svedrov 6-delni KWB

- multi-spirala za optimalno odstranjevanje prahu
- minimalno trenje in segrevanje
- optimirane vibracije
- **set vsebuje:**
- svedri:
  - ø 5 x 110 mm
  - ø 6 x 110 mm
  - ø 8 x 160 mm
  - ø 10 x 240 mm
- ploščato dleto: 250 x 14 x 20 mm
- koničasto dleto: 240 x 14 mm
- PVC škatla

### Svedri za beton HM po standardu ISO 5468



Šifra	Naziv	Premer (ø) mm	Vpetje (ø) mm
088263	039-630 Sveder HM/HW ISO 5468 3 mm KWB	3	3
088264	039-640 Sveder HM/HW ISO 5468 4 mm KWB	4	4
088265	039-650 Sveder HM/HW ISO 5468 5 mm KWB	5	5
088266	039-660 Sveder HM/HW ISO 5468 6 mm KWB	6	6
088267	039-670 Sveder HM/HW ISO 5468 7 mm KWB	7	7
088268	039-680 Sveder HM/HW ISO 5468 8 mm KWB	8	8
088269	039-700 Sveder HM/HW ISO 5468 10 mm KWB	10	10
088270	039-720 Sveder HM/HW ISO 5468 12 mm KWB	12	10
088271	039-740 Sveder HM/HW ISO 5468 14 mm KWB	14	10
088272	039-760 Sveder HM/HW ISO 5468 16 mm KWB	16	12

- za kamen, beton, opeko
- karbidna konica
- za rotacijske in udarne vrtnike



### Svedri za beton SDS-plus HB 44



4 delni set

Šifra	Naziv	mm	mm
088061	2404-00 SDS Svedri 5-10 mm 4 delni KWB	50	110
088063	2408-00 SDS Svedri 5-10 mm 160 mm 4 delni KWB	100	160

- za beton, opeko
- **komplet vsebuje:**  
svedri s premeri  $\varnothing$  5, 6, 8, 10 mm  
PVC kasete za svedre

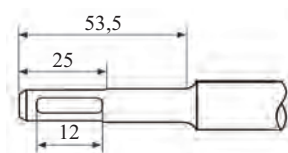

### Svedri za beton HM po standardu ISO 5468



4 delni set

Šifra	Naziv	Vpetje hex
088053	0508-00 Svedri HM hex 5-10 mm 4 delni KWB	6

- za granit, beton, zid, naravni in umetni kamen, apnenec
- karbidna konica
- poliran
- asimetrična spirala za boljše odstranjevanje prahu
- **komplet vsebuje:**  
svedri s premeri:  $\varnothing$  5, 6, 8, 10 mm  
PVC kasete za svedre

### Svedri za keramiko



4 delni set

Šifra	Naziv
088054	0513-00 Svedri za keramiko 4-8 mm 4 delni KWB

- za keramične stenske in talne ploščice, strešnike
- ekstra trda volfram-titan karbidna konica TSM
- diamantna rezalna površina
- izklop kladiva pri udarnih vrtnikih
- **komplet vsebuje:**  
svedri s premeri:  $\varnothing$  4, 5, 6, 8 mm  
PVC kasete za svedre



### Svedri za keramiko in steklo



5 delni set

Šifra	Naziv
-------	-------

<b>088690</b>	1770-00 Svedri za keramiko 4-10 mm 5 delni KWB
---------------	--

- za steklo, porcelan, keramične stenske in talne ploščice
- izklop kladiva pri udarnih vrtnikih
- **komplet vsebuje:**  
svedri s premeri:  $\varnothing$  4, 5, 6, 8, 10 mm  
PVC kasetna za svedre

### Večnamenski svedri



5 delni set

Šifra	Naziv
-------	-------

<b>088248</b>	0483-00 Svedri HM 3-8 mm 5 delni KWB
---------------	--------------------------------------

- za zid, opeko, kamen, beton, granit, marmor, stenske keramične ploščice, trd in mehak les, plastiko, akril, legirano in nelegirano jeklo, steklo, kristal
- ekstra trda volfram-titan karbidna konica TSM, diamantna rezalna površina
- izklop kladiva pri udarnih vrtnikih
- **komplet vsebuje:**  
svedri s premeri:  $\varnothing$  3, 4, 5, 6, 8 mm  
PVC kasetna za svedre

### Večnamenski svedri po standardu ISO 5468



5 delni set

Šifra	Naziv
-------	-------

<b>088689</b>	0395-00 HM/HW Sveder ISO 5468 4-10 mm KWB
---------------	---

- za beton, kamen, granit, opeko, marmor, keramiko, les, legirano jeklo, nelegirano jeklo, plastiko, akril, steklo, kristal
- zelo trda wolfram-titan HM konica
- asimetrično oblikovana spirala za optimalno vrtnanje
- **komplet vsebuje:**  
svedri s premeri:  $\varnothing$  4, 5, 6, 8, 10 mm  
PVC kasetna za svedre



### Diamantni set za vrtanje



8 delni set

Šifra	Naziv
-------	-------

087893	4999-00 Diamantni set za vrtanje 8-delni
--------	--

- 7 svedrov:  $\varnothing$  4, 5, 6, 7, 8, 10, 12 mm
- vakumska šablona za vrtanje
- natančno vrtanje s čistimi robovi
- vpetje svedrov: 1/4" E 6,3
- priključek za vodni sistem za hlajenje svedrov
- pri udarnem vrtnanju je treba izklopiti udarce
- v PVC škatli



### Omejilci za sveder



Šifra	Naziv
-------	-------

088031	5303-00 Omejilci za sveder 6,8,10 mm
--------	--------------------------------------

- za svedre:  $\varnothing$  6, 8, 10 mm
- nastavitev omejitve globine vrtnanja
- enostavna pritrditev na sveder s pomočjo vijaka

### Brusilnik svedrov



Šifra	Naziv
-------	-------

088709	5032-00 Brusilnik svedrov 3,5-10 mm KWB
--------	---

- za brušenje svedrov iz hitroreznega jekla HSS
- za svedre  $\varnothing$  3,5-10 mm
- kovinsko vodilo
- kot 118°



### Vpenjalo za sveder



Šifra	Naziv	Dolžina mm	Luknja ( $\emptyset$ ) mm	Navoj mm
111399	P156 10x47 mm Vpenjalo za sveder	46	10	M10

### Grezilo za sveder



Šifra	Naziv
111398	P161 5x16 mm Grezilo za sveder

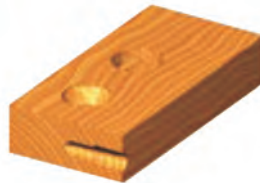

Primer uporabe

### Primer: vpenjalo za sveder, grezilo in sveder

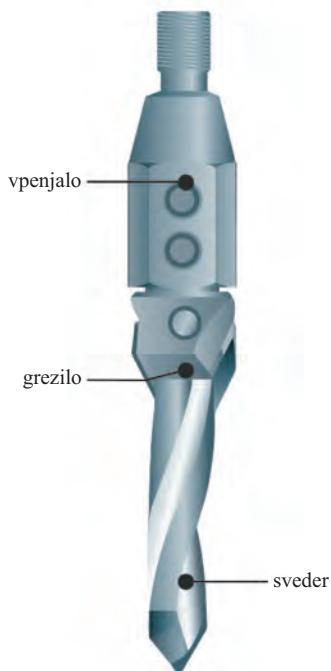

Primer uporabe





## Grežilo



Šifra	Naziv	Premer (ø) mm	Vpetje (ø) mm
<b>088949</b>	7042-10 Grežilo fi 8 mm KWB	8	8
<b>088950</b>	7043-10 Grežilo fi 12 mm KWB	12	8
<b>088951</b>	7044-10 Grežilo fi 16 mm KWB	16	8

- material: ogljikovo jeklo
- kot 90°
- 5 rezilnih robov
- za les in neželezne kovine

## Grežilo



Šifra	Naziv	Premer (ø) mm	Vpetje (ø) mm
<b>088956</b>	7042-40 Grežilo HSS fi 8 mm KWB	8	8
<b>088957</b>	7043-40 Grežilo HSS fi 12 mm KWB	12	8
<b>088958</b>	7044-40 Grežilo HSS fi 16 mm KWB	16	8

- material: hitrorezno jeklo HSS
- kot 90°
  - 5 rezilnih robov
  - za kovino

## Grežilo



Šifra	Naziv	Premer (ø) mm	Vpetje hex
<b>088952</b>	7046-10 Grežilo fi 10 mm KWB	10	1/4 "
<b>088953</b>	7047-10 Grežilo fi 13 mm KWB	13	1/4 "
<b>088954</b>	7048-10 Grežilo fi 16 mm KWB	16	1/4 "

- material: ogljikovo jeklo
- kot 90°
- 7 rezilnih robov
- za les in neželezne kovine

## Grežilo



Šifra	Naziv	Premer (ø) mm	Vpetje hex
<b>088959</b>	7046-40 Grežilo HSS fi 10 mm KWB	10	1/4 "
<b>088960</b>	7047-40 Grežilo HSS fi 12 mm KWB	12	1/4 "
<b>088961</b>	7048-40 Grežilo HSS fi 16 mm KWB	16	1/4 "

- material: hitrorezno jeklo HSS
- kot 90°
- 3 rezilni robovi
- za kovino

## Grežilo



Šifra	Naziv	Premer (ø) mm	Vpetje (ø) mm
<b>192333</b>	7045-40 Grežilo HSS fi 20 mm KWB	20	8

- material: hitrorezno jeklo HSS
- kot 90°
- 5 rezilnih robov
- za kovino



### Grežilo - 3 delni set



Šifra	Naziv
-------	-------

088955	5111-00 Grežilo fi 8,12,16 mm KWB
--------	-----------------------------------

- material: ogljikovo jeklo
- premer grezil:  $\varnothing$  8, 12, 16 mm
- kot 90°
- 1 rezilni rob
- za les in neželezne kovine

**FAMAE**  
FAMAE

## Grezilo



Šifra	Naziv	Premer (ø) mm	Dolžina mm	Vpetje šestrobo
076165	3532.012 Grezilo WS 12 mm	12	50	1/4 "
076166	3532.016 Grezilo WS 16 mm	16	50	1/4 "

- material: legirano jeklo
- 5 rezilnih robov
- kot: 90°

**wiha**  
Tools that work for you

## Grezilo



Šifra	Naziv	Premer (ø) mm	Dolžina mm	Vpetje hex
074900	7806 Grezilo 8,3 x 35 mm Wiha	2,0-8,3	35	1/4 "
074901	7806 Grezilo 10,4 x 35 mm Wiha	2,5-10,4	35	1/4 "
074902	7806 Grezilo 12,4 x 35 mm Wiha	2,8-12,4	35	1/4 "

- material: zelo kakovostno HSS jeklo
- univerzalna uporaba za kovino, plastiko, les
- izjemno odstranjevanje odrezkov zagotavlja gladko površino

**kwb**  
WE LOVE PERFECTION.

## Natično grezilo



Šifra	Naziv	Premer (ø) mm	Dolžina mm
088732	5130-50 Grezilo natično 12x19 mm 3 del. KWB	12	19

- material: ogljikovo jeklo
- kot 90°
- 5 rezilnih robov
- za svedre s premeri: ø 4, 5, 6 mm
- za uporabo s HSS in lesnimi svedri

## Nastavljivo grezilo



Šifra	Naziv	Sveder (ø) mm
097235	5120-04 Grezilo nastavljivo 4 mm	4
097236	5120-05 Grezilo nastavljivo 5 mm	5

- idealno za trd les (npr. za terase)
- material: HSS-M2
- max. premer grezila: ø 12 mm
- vpetje: hex 6,3 mm
- priložena imbus ključa: 2,0 in 2,5 mm

## Ročno grezilo



Šifra	Naziv	Premer (ø) mm
088983	1495-00 Grezilo ročno fi 12 mm	12

- rezilo: ogljikovo jeklo
- kot 90°
- ročaj: PVC



### Ročno grežilo



Šifra	Naziv	Premer (ø) mm
076002	3533.012 Grežilo ročno 12 mm	12
076003	3533.016 Grežilo ročno 16 mm	16

- 5 rezilnih robov
- kot 90°
- PVC ročaj

### Strgala za les in barvne kovine



les

kovina

Šifra	Naziv	Vpetje (ø) mm
088730	4955-00 Set profilov za strganje 6 delni KWB	6

- za les:
  - cilindrični okrogli: 13x35 mm
  - cilindrični: 16x30 mm
  - konični: 15x35 mm
  - okrogli: ø 16 mm
- za barvne kovine:
  - cilindrični: 16x30 mm
  - konični: 15x35 mm

### Rezkarji za izdelavo čepov



Šifra	Naziv	Premer (ø) mm	Dolžina mm	Vpetje (ø) mm
088680	7069-00 Rezkar za izdelavo čepov fi 10, 12, 16 mm	10, 12, 16	17	8

- polirani rezalni robovi

### Nož za pločevino



Šifra	Naziv	Premer (ø) mm
097200	5257-00 Nož za pločevino fi 35 mm KWB	35

- za rezanje lukenj v pločevino



### Navojni svedri, navojne čeljusti



Šifra	Naziv
-------	-------

088981	4428-00 Garnitura navojnih rezil KWB
--------	--------------------------------------

- 31 delni set
- **komplet vsebuje:**
- 7 x 3 navojne svedre: M3, M4, M5, M6, M8, M10, M12
- 7 navojnih čeljusti: M3, M4, M5, M6, M8, M10, M12
- držalo za navojne svedre
- držalo za navojne čeljusti
- merilnik koraka navoja
- izvijajč
- kovinska škatla

### Navojni svedri, navojne čeljusti



Šifra	Naziv
-------	-------

088982	4451-00 Garnitura navojnih rezil KWB
--------	--------------------------------------

- 20 delni set
- **komplet vsebuje:**
- 9 navojnih svedrov: M3, M4, M5, M6, M7, M8, M9, M10, M12
- 9 navojnih čeljusti: M3, M4, M5, M6, M7, M8, M9, M10, M12
- držalo za navojne svedre M3-M12
- držalo za navojne čeljusti M25
- PVC škatla



### Navojni svedri, navojne čeljusti



Šifra	Naziv
-------	-------

088067	4452-90 Navojna garnitura 16 delna
--------	------------------------------------

- 16 delni set
- **komplet vsebuje:**
- 7 navojnih svedrov: M3, M4, M5, M6, M8, M10, M12
- 7 navojnih čeljusti: M3, M4, M5, M6, M8, M10, M12
- držalo za navojne svedre M3-M12
- držalo za navojne čeljusti M25
- PVC škatla

### Zelo zmogljiva kronska žaga HSS Bi-Metal



Vario

Šifra	Naziv	Premer (ø) mm	Globina reza mm
155317	4932 3672 52 Žaga kronska 25 mm AEG	25	32
155318	4932 3672 55 Žaga kronska 32 mm AEG	32	32
155319	4932 3672 56 Žaga kronska 35 mm AEG	35	32
155320	4932 3672 58 Žaga kronska 40 mm AEG	40	32
155321	4932 3672 60 Žaga kronska 44 mm AEG	44	32
155323	4932 3672 63 Žaga kronska 51 mm AEG	51	32
155325	4932 3672 65 Žaga kronska 54 mm AEG	54	32
155326	4932 3672 66 Žaga kronska 57 mm AEG	57	32
151622	4932 3672 67 Žaga kronska 60 mm AEG	60	32
155327	4932 3672 68 Žaga kronska 64 mm AEG	64	32
155328	4932 3672 69 Žaga kronska 65 mm AEG	65	32
151623	4932 3715 80 Žaga kronska 68 mm AEG	68	32
155330	4932 3672 71 Žaga kronska 70 mm AEG	70	32
155331	4932 3672 72 Žaga kronska 73 mm AEG	73	32
155332	4932 3672 73 Žaga kronska 76 mm AEG	76	32
151626	4932 3672 74 Žaga kronska 79 mm AEG	79	32
155333	4932 3672 75 Žaga kronska 83 mm AEG	83	32
155335	4932 3672 77 Žaga kronska 89 mm AEG	89	32
155336	4932 3672 78 Žaga kronska 92 mm AEG	92	32
151624	4932 3672 79 Žaga kronska 95 mm AEG	95	32
155337	4932 3672 80 Žaga kronska 98 mm AEG	98	32
155338	4932 3672 81 Žaga kronska 102 mm AEG	102	32
155339	4932 3672 82 Žaga kronska 105 mm AEG	105	32
155341	4932 3672 84 Žaga kronska 114 mm AEG	114	32
155342	4932 3672 85 Žaga kronska 121 mm AEG	121	32
155343	4932 3672 86 Žaga kronska 127 mm AEG	127	32
155345	4932 3672 88 Žaga kronska 152 mm AEG	152	32

Zelo zmogljive kronske žage Bi-Metal (zgradba iz dveh različnih kovin) AEG izpolnjujejo vse zahteve in so primerne za vse vrste uporabe. Zobje iz hitroreznega jekla so z elektronskim snopom privarjeni na telo iz visokolegiranega jekla za maksimalno trpežnost in dolgo življenjsko dobo. Variabilni 4/6 razmik med zobmi (Vario).

- izboljšano odvajanje ostružkov in manjši podajalni pritisk po zaslugi različno globokih prostorov za odrezke med zobmi (Vario)
- manjše segrevanje za dolgotrajnejšo ostrino zob, hitrejše in učinkovitejše rezanje
- za les, tanke neželezne kovine, PVC in kombinacijo omenjenih materialov.

### Držalo za kronsko žago



Šifra	Naziv	Sveder (ø) mm	Vpetje hex
151698	4932-3674-22 Adapter 5/8"x20 fi 14-30 mm	6	9

- centrirni sveder vključen
- za kronske žage ø 14 - 30 mm (glej tabelo zgoraj)

### Držalo za kronsko žago



Šifra	Naziv	Sveder (ø) mm	Vpetje hex
151625	4932-3674-21 Adapter 5/8"x18 fi 32-152 mm	6	11

- centrirni sveder vključen
- za kronske žage ø 32 - 152 mm (glej tabelo zgoraj)



### Univerzalna kronska žaga s karbidno trdino TCT



Šifra	Naziv	Premer (ø) mm	Dolžina mm	Število zob
155300	4932 3991 00 Žaga kronska HM 25 mm TCT	25	60	3
155301	4932 3991 01 Žaga kronska HM 30 mm TCT	30	60	3
155302	4932 3991 02 Žaga kronska HM 35 mm TCT	35	60	3
155303	4932 3991 03 Žaga kronska HM 40 mm TCT	40	60	3
155304	4932 3991 04 Žaga kronska HM 45 mm TCT	45	60	3
155305	4932 3991 05 Žaga kronska HM 50 mm TCT	50	60	3
155306	4932 3991 06 Žaga kronska HM 55 mm TCT	55	60	3
151600	4932 3991 08 Žaga kronska HM 60 mm TCT	60	60	5
155308	4932 3991 09 Žaga kronska HM 63 mm TCT	63	60	5
151604	4932 3991 10 Žaga kronska HM 65 mm TCT	65	60	5
151601	4932 3991 11 Žaga kronska HM 68 mm TCT	68	60	5
155309	4932 3991 12 Žaga kronska HM 70 mm TCT	70	60	5
155311	4932 3991 14 Žaga kronska HM 74 mm TCT	74	60	5
155312	4932 3991 15 Žaga kronska HM 76 mm TCT	76	60	5
155313	4932 3991 16 Žaga kronska HM 78 mm TCT	78	60	5
151602	4932 3991 17 Žaga kronska HM 80 mm TCT	80	60	5
155314	4932 3991 18 Žaga kronska HM 85 mm TCT	85	60	5
155315	4932 3991 19 Žaga kronska HM 90 mm TCT	90	60	5
155316	4932 3991 20 Žaga kronska HM 105 mm TCT	105	60	6

Univerzalne kronske žage TCT so idealne za električarje, tesarje, montažerje kuhinj ter vse strokovnjake na področju ogrevanja, ventilacije in vodovodnih inštalacij. Vse kronske žage s karbidno trdino imajo vpenjalni navoj M 16 in so primerne za vpenjalne trne z vpetjem FIXTEC SDS-plus in Hex 11. Vpenjalni trn FIXTEC in centrirni sveder je treba dodatno priskrbeti. Univerzalne kronske žage iz karbidne trdine se lahko uporabljajo s pnevmatskimi vrtalnimi kladivi z vpetjem SDS-plus in vsemi rotacijskimi/udarnimi električnimi in akumulatorskimi vrtalniki.

- **pomembno:** pri uporabi teh kronskih žag mora biti udarni način/način kladiva izklopljen
- **trdnost in trpežnost:** zobje iz volframovega karbida so trdno vdelani v telo žage (pritrditev v obliki lastovičjega repa), kar zagotavlja trdnejšo povezavo med materiali in manjšo verjetnost zloma zob
- **odvajanje materiala:** velike komore za prah zagotavljajo hitro in učinkovito odvajanje materiala
- **zaščita:** univerzalne kronske žage iz karbidne trdine se ne smejo uporabljati v udarnem načinu delovanja, vendar pa se pri uporabi vpenjalnega trna FIXTEC SDS-plus v primeru neizključenega udarnega načina kronska žaga ne bo poškodovala. Vpenjalni trn FIXTEC SDS-plus je namreč zasnovan s krajšimi utori kot običajno, kar preprečuje, da bi pnevmatsko kladivo delovalo v udarnem načinu.
- **uporaba:** vgradnja doz električnih stikal in razdelilnih doz  
montaža usmerjenih reflektorjev in vgradnih stropnih luči  
izvrtine za prehod kablov, vodovodnih cevi ter za centralno ogrevanje  
izvrtine za cevi za prezračevanje in odsesavanje



### Set kronske žage HSS Bi-Metal



Vario

Šifra	Naziv	Globina reza mm
088790	5982-00 Set kronske žage 8 delni KWB	38

Zelo zmogljive kronske žage Bi-Metal (zgradba iz dveh različnih kovin) izpolnjujejo vse zahteve in so primerne za vse vrste uporabe. Variabilni 4/6 razmik med zobmi (Vario).

- za jeklo, lito železo, inox, pločevino, aluminij, bron, baker, plastiko, akril, mavčne plošče, mehak les, laminat, lahke gradbene materiale
- material: hitrorezno jeklo HSS Bi-Metal
- izboljšano odvajanje ostružkov in manjši podajalni pritisk po zaslugi različno globokih prostorov za odrezke med zobmi (Vario)
- manjše segrevanje za dolgotrajnejšo ostrino zob
- hitrejše in učinkovitejše rezanje
- za jeklo, železo, aluminij, baker, les, PVC in kombinacijo omenjenih materialov

**- komplet vsebuje:**

- kronske žage s premeri:  $\varnothing$  20, 29, 35, 40, 51, 68 mm
- 2 x držalo kronske žage s centrirnim svedrom  $\varnothing$  6 mm
- PVC kovček

### Set kronske žage - 6 delni



Šifra	Naziv
192313	4991-76 Set kronske žage 6-delni KWB

- za kamen, beton, granit, marmor, opeko, siporeks
- posebno spajkane toplotno odporne karbidne ploščice odporne na udarce
- dolga življenjska doba

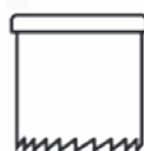

1X  $\varnothing$  68 mm  
1X  $\varnothing$  82 mm

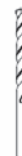

2X  $\varnothing$  8x110 mm



1X 100 mm  
SDS-Plus



1X M6

### Set kronske žage - 8 delni



Šifra	Naziv
192312	1091-78 Set kronske žage 8-delni KWB

- za trd in mehak les, vezan les, mavčne plošče, laminat
- pospešeno odvajanje odrezkov
- HSS centrirni sveder
- dolga življenjska doba

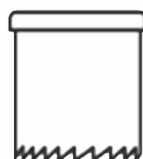

1X  
 $\varnothing$  67, 76, 89,  
102, 127 mm



1X



1X



1X





### Jeklene kronske žage



Šifra	Naziv	Globina reza mm
192273	4989-20 Kronska žaga 25-68 mm 8 delna KWB	28

- premeri kronske žage:  $\varnothing$  25, 32, 38, 44, 51, 57, 63, 68 mm
- patentirani utori za boljše in hitrejše delovanje
- žagini listi iz vzmetnega jekla, zobje induktivno kaljeni in zelo ostri
- hitrejše žaganje in odstranjevanje žaganja, manj trenja, manj časa
- posebej primerne za baterijska orodja, ker porabijo manj energije
- za les, plastificiran les, trd les, iverne plošče, mavčne plošče, lahke gradbene plošče, plastiko, baker



### Jeklene kronske žage



Šifra	Naziv	Globina reza mm
192272	4987-20 Kronska žaga 57-94 mm 7 delna KWB	30

- premeri kronske žage:  $\varnothing$  46, 53, 59, 66, 73, 82, 94 mm
- patentirani utori za boljše in hitrejše delovanje
- žagini listi iz vzmetnega jekla, zobje induktivno kaljeni in zelo ostri
- hitrejše žaganje in odstranjevanje žaganja, manj trenja, manj časa
- posebej primerne za baterijska orodja, ker porabijo manj energije
- za les, plastificiran les, trd les, iverne plošče, mavčne plošče, lahke gradbene plošče, plastiko, baker



### Jeklene kronske žage



Šifra	Naziv	Globina reza mm
088681	5991-00 Kronska žaga 7 delna fi 25-63x40 mm	40

- 7 delni set jeklenih kronske žage
- material: kaljeno vzmetno jeklo, nosilna plošča liti alumini
- kaljeni zobje
- premer kronske žage:  $\varnothing$  25, 32, 38, 45, 50, 58, 63 mm
- za trd in mehak les, PVC, mavčne plošče, lahke gradbene materiale

### Jeklene kronske žage



Šifra	Naziv	Globina reza mm
088808	5990-00 Kronska žaga 7 delna fi 25-63x18 mm	18

- 7 delni set jeklenih kronske žage
- material: kaljeno vzmetno jeklo, nosilna plošča liti alumini
- kaljeni zobje
- premer kronske žage:  $\varnothing$  25, 32, 38, 45, 50, 58, 63 mm
- za trd in mehak les, PVC, mavčne plošče, lahke gradbene materiale



### Jeklene kronske žage



Šifra	Naziv	Globina reza mm
088806	4988-00 Kronska žaga 6 delna fi 46-81 mm KWB	32

- 6 delni set jeklenih kronske žage
- material: kaljeno vzmetno jeklo, nosilna plošča liti cink
- zobje induktivno kaljeni
- premer kronske žage:  $\varnothing$  46, 53, 60, 68, 74, 81 mm
- za trd in mehak les, plastificiran les, PVC, barvne kovine, mavčne plošče, lahke gradbene materiale

### Jeklene kronske žage



Šifra	Naziv	Globina reza mm
088807	4997-00 Kronska žaga 5 delna fi 68-100 mm KWB	32

- 5 delni set jeklenih kronske žage
- material: kaljeno vzmetno jeklo, nosilna plošča liti cink
- zobje induktivno kaljeni
- premer kronske žage:  $\varnothing$  68, 74, 80, 90, 100 mm
- za trd in mehak les, plastificiran les, PVC, barvne kovine, mavčne plošče, lahke gradbene materiale



### Grežilo



Šifra	Naziv	Premer (ø) mm	Število zob	Debelina zoba mm
151603	4932 3991 27 Žaga kronska utor 68 mm AEG	68	3	2

- ko je nameščeno na kronsko žago omogoča idealno naleganje doz električnih stikal v stenah iz suhomontažnih/mavčnih plošč
- na kronsko žago se namesti z zadnje strani, da posname rob izvrtine

### Centrirni sveder HM



Šifra	Naziv	Premer (ø) mm	Dolžina mm
151615	4932 3991 25 Sveder kr. ž. HM 8x120 TCT	8,0	120

- centrirni sveder se lahko namesti v vpenjalne trne Fixtec
- za vrtnanje v zidove, opeko

### Centrirni sveder HSS



Šifra	Naziv	Premer (ø) mm	Dolžina mm
151616	4932 3991 26 Sveder kr. ž. HSS 7,4x120	7,4	120

- centrirni sveder se lahko namesti v vpenjalne trne Fixtec
- za vrtnanje v les in PVC

### Vpenjalni trn SDS-plus Fixtec



Šifra	Naziv	Dolžina mm	Vpetje	Navoj
151610	4932 3991 21 Adapter SDS 118 mm Fixtec	118	SDS-plus	M16
151627	4932 3991 34 Adapter SDS 220 mm Fixtec	220	SDS-plus	M16
151628	4932 3991 22 Adapter SDS 370 mm Fixtec	370	SDS-plus	M16

- za pritrditev kronske žage in centrirnega svedra
- hitra in enostavna pritrditev centrirnega svedra

### Vpenjalni trn HEX Fixtec



Šifra	Naziv	Dolžina mm	Vpetje	Navoj
151611	4932 3991 23 Adapter HEX 118 mm Fixtec	118	hex 11	M16
151629	4932 3991 24 Adapter HEX 370 mm Fixtec	370	hex 11	M16

- za pritrditev kronske žage in centrirnega svedra
- hitra in enostavna pritrditev centrirnega svedra



primer sestave vpenjalnega trna, kronske žage in centrirnega svedra



### Listi za vbodne žage

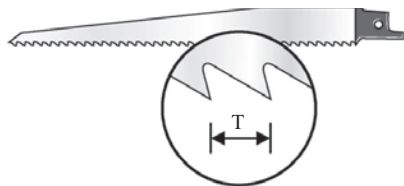

### Tehnični nasveti

Razmik med zobmi se meri od konice do konice zoba (T). Izbira ustreznega razmika med zobmi je odvisna od debeline obdelovanca.

**Zlato pravilo:** trije zobje lista se morajo vedno dotikati obdelovanca. Na primer: za kovino debeline nad 4 mm se priporoča razmik med zobmi 2 mm. Za kovine debeline 1,5-3,5 mm je priporočljiv razmik med zobmi od 1,2-1,4 mm, pri rezanju tanke kovine z debelino pod 1,5 mm pa je priporočen razmik med zobmi od 0,7-1,2 mm. Splošno pravilo pri rezanju lesa: večji kot je razmik med zobmi, hitrejši, a bolj grob je rez. Pri rezanju izredno tankega materiala je priporočeno, da se obdelovanec položi na debelejšo podlago, da se obdelovanec ne zlomi. Priporoča se uporaba hladilnega sredstva pri rezanju kovin in plastike za podaljšanje življenjske dobe žaginega lista.

### Kakovost materiala

**HCS** - List za vbodno žago iz jekla z visokim deležem ogljika se uporablja za rezanje vseh vrst lesa in plastike

**HSS** - List iz hitroreznega jekla se uporablja za rezanje kovin, neželeznih kovin in aluminija

**Bi-Metal** - Bi-metalni listi imajo zobe iz hitroreznega jekla, ki so z elektronskim snopom privarjeni na fleksibilni hrbet iz legiranega jekla. Ti listi ponujajo največjo možno zmogljivost pri najzahtevnejših pogojih rezanja lesa in kovine.

#### Prednosti Bi-metalnih listov

- prilagodljivost in manjša nevarnost loma
- daljša življenjska doba: listi za rezanje kovine zagotavljajo dvakrat, listi za les pa celo več kot petkrat daljšo življenjsko dobo od navadnih HCS in HSS listov
- velika odpornost proti obrabi in toploti zagotavlja dolgo trajnejšo ostrino zob
- hitreše rezanje



### List za vbodno žago

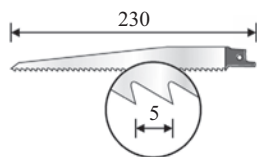

univerzalno 1/2 "

Šifra	Naziv	Pakirano kos	Pakirano
155101	48-00-5026 Žaga vbodna 230x5/8 AX P5M	5	

- za les, les z žebli, plastika
- material: Bi-Metal (zgradba iz dveh različnih kovin)
- debelina lista: 1,6 mm
- hitro rezanje
- dolga življenjska doba

### List za vbodno žago

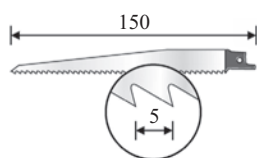

univerzalno 1/2 "

Šifra	Naziv	Pakirano kos	Pakirano
155100	48-00-5021 Žaga vbodna 150x5/8 AX P5M	5	

- za les, les z žebli, plastika
- material: Bi-Metal (zgradba iz dveh različnih kovin)
- debelina lista: 1,6 mm
- hitro rezanje
- dolga življenjska doba



### List za vbodno žago

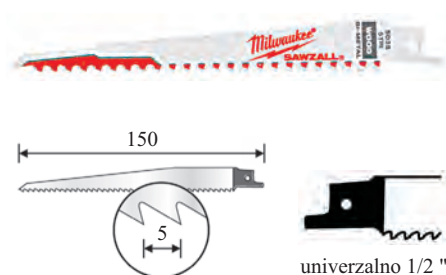

univerzalno 1/2 "

Šifra	Naziv	Pakirano kos	Pakirano
155106	48-00-5035 Žaga vbodna 150x6 P5M	5	

- za les, les z žebli, plastika
- material: Bi-Metal (zgradba iz dveh različnih kovin)
- debelina lista: 1,25 mm
- hitro rezanje
- dolga življenjska doba

### List za vbodno žago

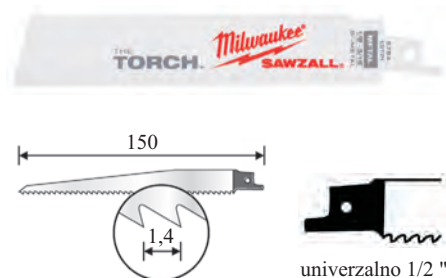

univerzalno 1/2 "

Šifra	Naziv	Pakirano kos	Pakirano
155109	48-00-5784 Žaga vbodna 150x18 P5M	5	

- za kovino
- material: Bi-Metal (zgradba iz dveh različnih kovin)
- debelina lista: 1,06 mm
- višina 25 mm za večjo stabilnost in minimalne vibracije
- zelo učinkovito rezanje
- dolga življenjska doba

### List za vbodno žago

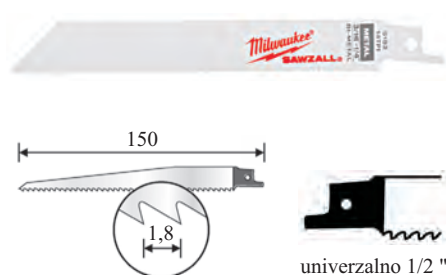

univerzalno 1/2 "

Šifra	Naziv	Pakirano kos	Pakirano
155525	48-00-5182 Žaga list 150x14 5 kos	5	

- za kovino
- material: Bi-Metal (zgradba iz dveh različnih kovin)
- debelina lista: 0,90 mm
- hitro rezanje
- dolga življenjska doba

### List za vbodno žago

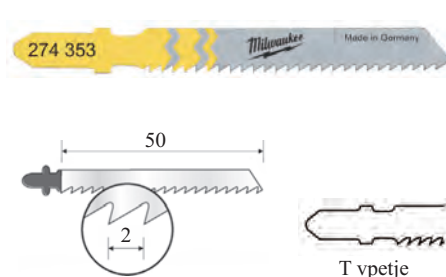

T vpetje

Šifra	Naziv	Pakirano kos	Pakirano
151630	4932-2743-53 T119B Žage vbodne 5 kos	5	

- za les, plastika
- standardni list za dobro in zanesljivo rezanje

### List za vbodno žago

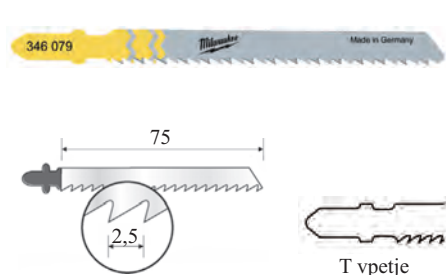

T vpetje

Šifra	Naziv	Pakirano kos	Pakirano
151636	4932-3460-79 T101BR Žage vbodne 5 kos	5	

- za les, iveral, plastika
- zobje so obrnjeni za rezanje navzdol
- zelo čist rez brez iveri za rezanje laminata in kuhinjskih pultov



### List za vbodno žago

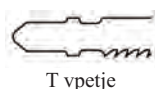
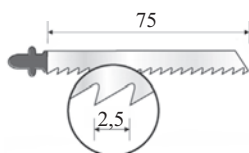

T vpetje

Šifra	Naziv	Pakirano kos	Pakirano
151633	4932-3733-90 T101BF Žage vbodne 5 kos	5	

- za les, iveral, plastika
- material: Bi-Metal (zgradba iz dveh različnih kovin)
- diagonalno brušeni zamaknjeni zobje za zelo čist rez brez iveri

### List za vbodno žago

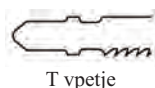
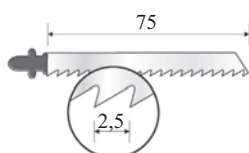

T vpetje

Šifra	Naziv	Pakirano kos	Pakirano
151632	4932-2540-61 T101B Žage vbodne 5 kos	5	

- za les, iveral, plastika
- diagonalno stransko brušeni zobje za zelo čist rez brez iveri

### List za vbodno žago

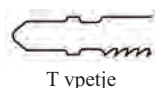
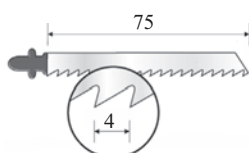

T vpetje

Šifra	Naziv	Pakirano kos	Pakirano
151634	4932-2743-51 T101D Žage vbodne 5 kos	5	

- za les, iveral, plastika
- material: Bi-Metal (zgradba iz dveh različnih kovin)
- diagonalno stransko brušeni zobje za zelo čist rez brez iveri

### List za vbodno žago

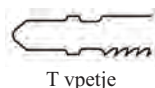
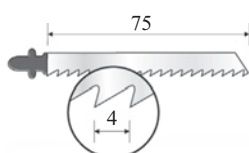

T vpetje

Šifra	Naziv	Pakirano kos	Pakirano
151631	4932-2131-16 T144D Žage vbodne 5 kos	5	

- za les
- ostra in agresivna geometrija zob
- zelo hitro žaganje

### List za vbodno žago

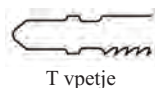
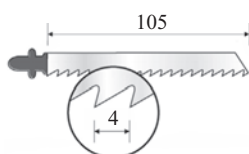

T vpetje

Šifra	Naziv	Pakirano kos	Pakirano
151635	4932-3460-71 T301DL Žage vbodne 5 kos AEG	5	

- za les, iveral, plastika
- diagonalno stransko brušeni zobje za zelo čist rez brez iveri

## List za vbodno žago

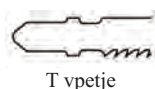
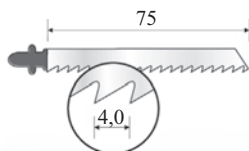

Šifra	Naziv	Pakirano kos	Pakirano
086649	6202-20 Žaga vbodna KWB	2	

- za les, iverne plošče, vlaknene plošče, laminat, plastika ojačana s steklenimi vlakni, plastika
- material: Bi-Metal (zgradba iz dveh različnih kovin)
- diagonalno brušeni zamaknjeni zobje za zelo čist rez brez iveri

## List za vbodno žago

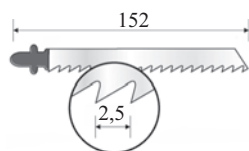

Šifra	Naziv	Pakirano kos	Pakirano
088542	6250-20 Žaga vbodna T350H 152x2,5 mm KWB	1	

- za trd in mehak les, laminat, vezane plošče, PVC
- HCS jeklo
- žagati lahko začnemo tudi na sredini obdelovanca
- ne potrebujemo luknje za začetek žaganja



### List za vbodno žago

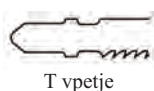
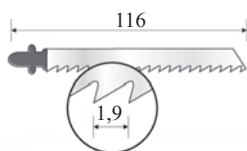

T vpetje

Šifra	Naziv	Pakirano kos	Pakirano
192281	6234-20 Vbodna žaga les akku-top KWB	2	

- material: HCS ogljikovo jeklo
- posebna oblika žaginega lista, optimizirana oblika zob, konično brušenje
- do 3 x večja hitrost rezanja, manjše trenje
- posebej primerni za baterijska orodja, ker porabijo manj energije
- za trd in mehak les, iverne plošče, laminat, parket, stropne in stenske obloge, plastiko



### List za vbodno žago

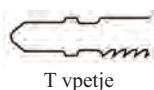
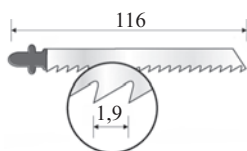

T vpetje

Šifra	Naziv	Pakirano kos	Pakirano
192282	6235-20 Vbodna žaga les, pl. akku-top KWB	2	

- material: HCS ogljikovo jeklo
- posebna oblika žaginega lista, 3 x brušeni zobje, stožčasto brušenje
- do 3 x večja hitrost rezanja, manjše trenje
- posebej primerni za baterijska orodja, ker porabijo manj energije
- za les, plastificiran les, trd les, laminat, parket, stropne in stenske obloge, plastiko



### List za vbodno žago

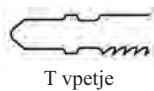
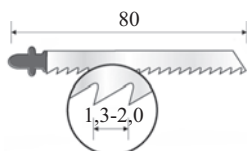

T vpetje

Šifra	Naziv	Pakirano kos	Pakirano
192297	6215-20 Vbodna žaga les akku-top KWB	2	

- material: Bi-Metal (zgradba iz dveh različnih kovin)
- patentirani dvojno rezilni zobje, posebna oblika žaginega lista
- spremenljiv razmik med zobmi
- do 2 x večja hitrost rezanja, manjše trenje
- posebej primerni za baterijska orodja, ker porabijo manj energije
- za kovino, neželezne kovine, plastiko, les, les z ostanki kovin



### List za vbodno žago

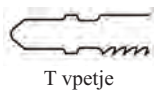
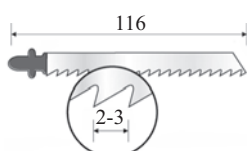

T vpetje

Šifra	Naziv	Pakirano kos	Pakirano
088514	6230-20 Žaga vbodna T234X 116x2 mm KWB	2	

- za les, iverne plošče, stavbno pohištvo, vlaknene plošče, mehka plastika
- za tanke in debele materiale
- material: HCS ogljikovo jeklo
- kaljeni zobje
- gladek rez
- napredno žaganje

### List za vbodno žago

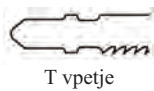
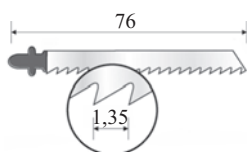

T vpetje

Šifra	Naziv	Pakirano kos	Pakirano
088518	6206-25 Žaga vbodna T101AO 76x1,35 mm KWB	5	

- za les, iverne plošče, plastificirane plošče, laminat, plastika
- material: Bi-Metal (zgradba iz dveh različnih kovin)
- za rezanje krivin





### List za vbodno žago

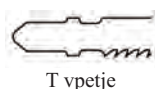
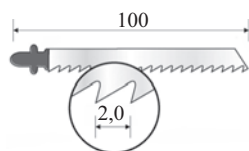

T vpetje

Šifra	Naziv	Pakirano kos	Pakirano
088532	6101-25 Žaga vbodna T111B 100x2 mm KWB	5	

- za les, iverne plošče, stavbno pohištvo, vlaknene plošče
- material: HCS ogljikovo jeklo

### List za vbodno žago

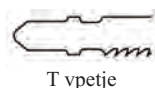
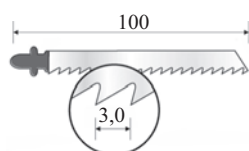

T vpetje

Šifra	Naziv	Pakirano kos	Pakirano
088533	6102-25 Žaga vbodna T111C 100x3 mm KWB	5	

- za les, iverne plošče, stavbno pohištvo, vlaknene plošče
- material: HCS ogljikovo jeklo
- kaljeni zobje

### List za vbodno žago

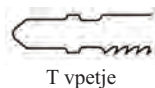
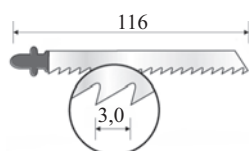

T vpetje

Šifra	Naziv	Pakirano kos	Pakirano
088541	6233-20 Žaga vbodna T301CD 116x3 mm KWB	2	

- za les, iverne plošče, plastificirane plošče, vlaknene plošče, plastika, plastika ojačana s steklenimi vlakni
- material: Bi-Metal (zgradba iz dveh različnih kovin)

### List za vbodno žago

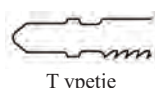
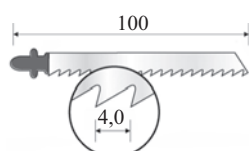

T vpetje

Šifra	Naziv	Pakirano kos	Pakirano
088534	6103-25 Žaga vbodna T111D 100x4 mm KWB	5	

- za les, iverne plošče, stavbno pohištvo, vlaknene plošče
- material: HCS ogljikovo jeklo

### List za vbodno žago

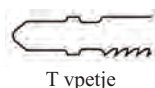
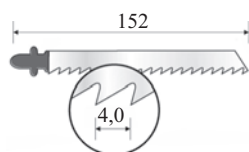

T vpetje

Šifra	Naziv	Pakirano kos	Pakirano
088540	6232-20 Žaga vbodna T344D 152x4 mm KWB	2	

- za les, iverne plošče, plastificirane plošče, vlaknene plošče, plastika, plastika ojačana s steklenimi vlakni
- material: Bi-Metal (zgradba iz dveh različnih kovin)



### List za vbodno žago

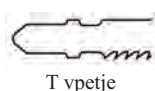
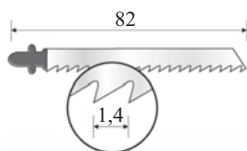

T vpetje

Šifra	Naziv	Pakirano kos	Pakirano
086648	6209-20 Žaga vbodna T101AOF 82x2 mm KWB	2	

- za les, laminat, plastificirane plošče, plastika
- material: Bi-Metal (zgradba iz dveh različnih kovin)
- kaljeni zobje
- za rezanje krivin

### List za vbodno žago

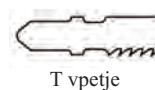
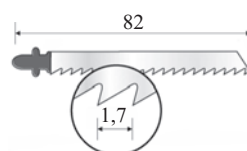

T vpetje

Šifra	Naziv	Pakirano kos	Pakirano
088647	6205-25 Žaga vbodna T101BIF 82x2 mm KWB	5	

- za les, laminat, plastificirane plošče
- material: Bi-Metal (zgradba iz dveh različnih kovin)
- kaljeni zobje

### List za vbodno žago

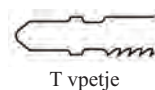
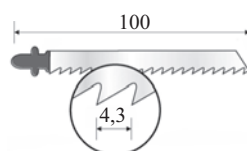

T vpetje

Šifra	Naziv	Pakirano kos	Pakirano
088074	6217-21 Žaga vbodna T141HM 100x4,3 mm KWB	1	

- za plastificirane plošče, plastika, plastika ojačana s steklenimi vlakni
- prevlečen z volfram karbidom

### List za vbodno žago

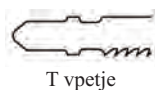
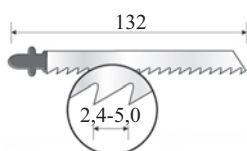

T vpetje

Šifra	Naziv	Pakirano kos	Pakirano
088529	6248-20 Žaga vbodna T345XF 132x2,4-5,0 mm KWB	2	

- za les, les z žebli, plastika, cevi in profili iz kovine in aluminija do 10 mm
- material: Bi-Metal (zgradba iz dveh različnih kovin)
- različen razmik med zobmi

### List za vbodno žago

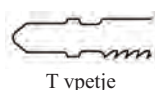
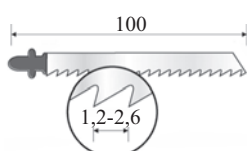

T vpetje

Šifra	Naziv	Pakirano kos	Pakirano
088523	6240-20 Žaga vbodna T123X 100x1,2-2,6 mm KWB	2	

- za tanke in debele pločevine 1,5 do 10 mm, kovina in aluminij do 30 mm, cevi, profili,
- material: Bi-Metal (zgradba iz dveh različnih kovin)
- kaljeni zobje
- različen razmik med zobmi



### List za vbodno žago

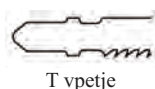
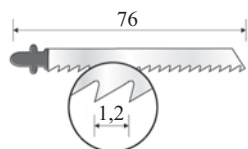

Šifra	Naziv	Pakirano kos	Pakirano
088524	6211-25 Žaga vbodna T118AF 76x1,2 mm KWB	5	

- pločevina do 3 mm, cevi in profili do 30 mm, aluminij, neželezne kovine, pleksi steklo
- material: Bi-Metal (zgradba iz dveh različnih kovin)

### List za vbodno žago

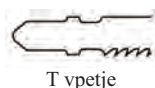
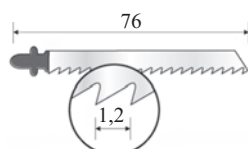

Šifra	Naziv	Pakirano kos	Pakirano
088535	6112-25 Žaga vbodna T118A 76x1,2 mm KWB	5	

- za pločevino do 3 mm, cevi in profili do 30 mm, aluminij, neželezne kovine, pleksi steklo
- material: Bi-Metal (zgradba iz dveh različnih kovin)

### List za vbodno žago

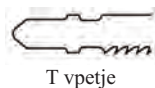
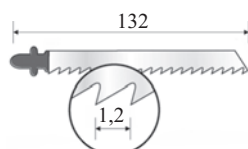

Šifra	Naziv	Pakirano kos	Pakirano
088527	6242-20 Žaga vbodna T318A 132x1,2 mm KWB	2	

- za pločevino in perforirano pločevino do 3 mm, cevi in profili do 65 mm, aluminij, neželezne kovine, sendvič materiali, pleksi steklo
- material: HSS hitrorezno jeklo

### List za vbodno žago

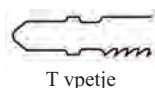
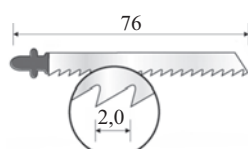

Šifra	Naziv	Pakirano kos	Pakirano
088536	6113-25 Žaga vbodna T118B 76x2 mm KWB	5	

- za kovino, aluminij, neželezne kovine
- material: HSS hitrorezno jeklo
- kaljeni brušeni zobje

### List za vbodno žago

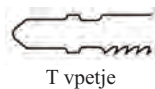
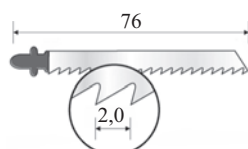

Šifra	Naziv	Pakirano kos	Pakirano
088525	6212-25 Žaga vbodna T118BF 76x2 mm KWB	5	

- za pločevino do 3 mm, cevi in profili do 30 mm, aluminij, neželezne kovine, pleksi steklo
- material: Bi-Metal (zgradba iz dveh različnih kovin)



### List za vbodno žago

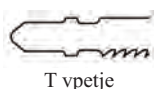
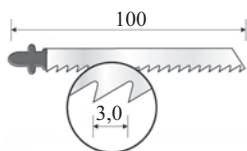

Šifra	Naziv	Pakirano kos	Pakirano
088526	6213-25 Žaga vbodna T127DF 100x3 mm KWB	5	

- za pločevino do 3 mm, cevi in profili do 30 mm, aluminij, neželezne kovine, pleksi steklo
- material: Bi-Metal (zgradba iz dveh različnih kovin)

### List za vbodno žago

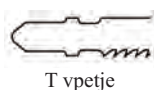
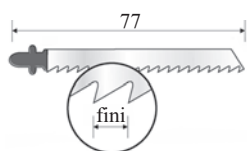

Šifra	Naziv	Pakirano kos	Pakirano
088521	6221-21 Žaga vbodna T150RF 77 mm KWB	1	

- za keramične ploščice, opeko, steklo, lito železo do 15 mm
- prevlečen z volfram karbidom
- material: HM

### List za vbodno žago

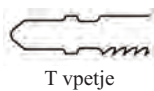
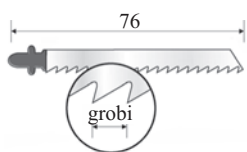

Šifra	Naziv	Pakirano kos	Pakirano
088522	6219-21 Žaga vbodna T130RF 76 mm KWB	1	

- za keramične ploščice, opeko, steklo, lito železo do 15 mm
- prevlečen z volfram karbidom
- material: HM

### Listi za vbodno žago

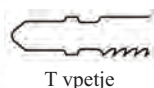

Šifra	Naziv	Pakirano
088539	6170-20 Žaga vbodna 10 delna KWB	

- za les in kovino
- material: HCS ogljikovo jeklo za les, HSS jeklo za kovino
- **komplet vsebuje:**
  - listi za les: 2 x fini razmik med zobmi, 2 x srednji razmik med zobmi, 2 x grobi razmik med zobmi, 2 x za rezanje krivin
  - lista za kovino: 2 x fini razmik med zobmi

### Nož za vbodno žago

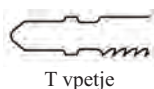
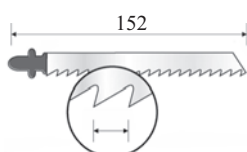

Šifra	Naziv	Pakirano kos	Pakirano
088528	6249-20 Nož vbodni T313AW 152 mm KWB	1	

- za mehko gumo, blago, stiropor, preprogo, pluto, karton
- material: HCS jeklo
- valovito rezilo



### List za žago lisičji rep

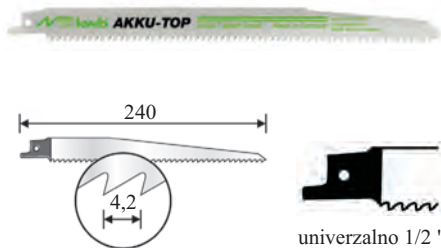

Šifra	Naziv	Pakirano kos	Pakirano
192274	5761-00 Žagin list za les akku top-KWB	2	

- material: HCS ogljikovo jeklo
- posebna oblika žaginega lista, optimizirana oblika zob
- 3 kratno brušenje, bočno brušenje,
- do 2 x hitrejša rezanje, manjše trenje
- posebej primerni za baterijska orodja, ker porabijo manj energije
- za trd in mehak les, gradbeni les, suh in moker les



### List za žago lisičji rep

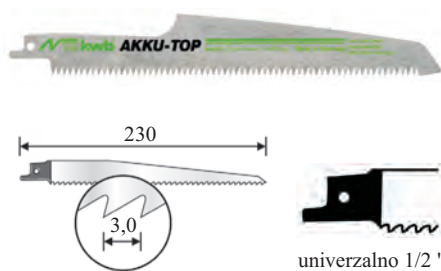

Šifra	Naziv	Pakirano kos	Pakirano
192275	5762-00 Žagin list jap. akku top-KWB	2	

- material: HCS ogljikovo jeklo
- posebna oblika žaginega lista, optimizirana oblika zob,
- japonski zobje, 3 kratno brušenje, zobje impulzno kaljeni, izredno ostri
- do 2 x hitrejša rezanje, manjše trenje
- posebej primerni za baterijska orodja, ker porabijo manj energije
- za trd in mehak les, gradbeni les, suh in moker les, plastiko



### List za žago lisičji rep

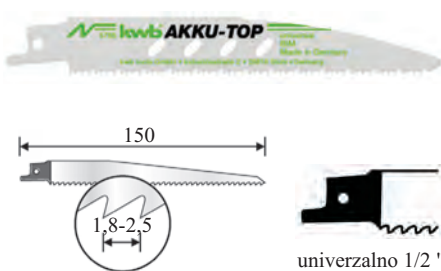

Šifra	Naziv	Pakirano kos	Pakirano
192276	5785-00 Žagin list železo akku-top KWB	2	

- material: Bi-Metal (zgradba iz dveh različnih kovin)
- posebna oblika žaginega lista s prežračevalnimi kanali
- spremenljiv razmik med zobmi, novi dvostopenjski zobje
- posebej primerni za baterijska orodja, ker porabijo manj energije
- za kovino, barvne kovine, plastiko, les z ostanki kovin, kombinacijo omenjenih materialov



### List za žago lisičji rep

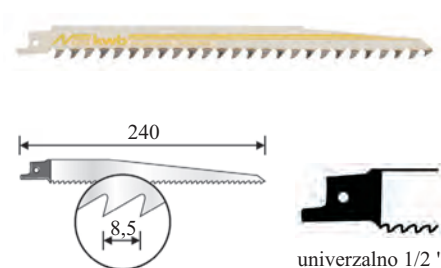

Šifra	Naziv	Pakirano kos	Pakirano
088555	5763-00 Žaga vbodna S1542K 240x8,5 mm KWB	2	

- za svež in suh les do 190 mm
- material: HCS ogljikovo jeklo
- kaljeni zobje

### List za žago lisičji rep

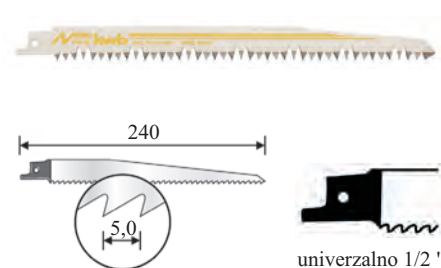

Šifra	Naziv	Pakirano kos	Pakirano
088556	5764-00 Žaga vbodna S1531L 240x5 mm KWB	2	

- za svež in suh les do 190 mm
- material: HCS ogljikovo jeklo
- kaljeni zobje



### List za žago lisičji rep

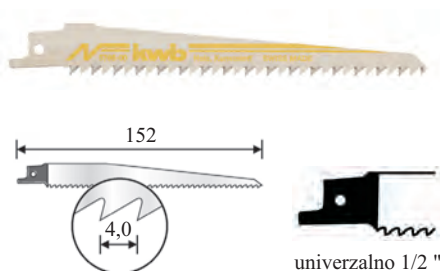

Šifra	Naziv	Pakirano kos	Pakirano
088552	Žaga vbodna S644D 152x4 mm KWB	2	

- za gradbeni les in lesene stene do 100 mm, iverne plošče in MDF plošče do 60 mm, vezan les in plastične plošče do 100 mm
- material: HCS ogljikovo jeklo
- kaljeni zobje

### List za žago lisičji rep

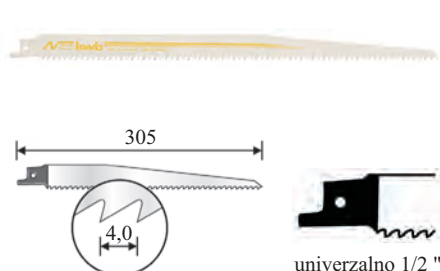

Šifra	Naziv	Pakirano kos	Pakirano
088553	Žaga vbodna S1411D 305x4 mm KWB	2	

- za gradbeni les in lesene stene do 100 mm, iverne plošče in MDF plošče do 60 mm, vezan les in plastične plošče do 100 mm
- material: HCS ogljikovo jeklo
- kaljeni zobje

### List za žago lisičji rep

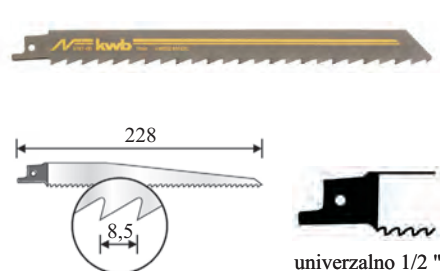

Šifra	Naziv	Pakirano kos	Pakirano
088554	Žaga vbodna S1111K 228x8,5 mm KWB	2	

- za gradbeni les in lesene stene do 100 mm, iverne plošče in MDF plošče do 60 mm, vezan les in plastične plošče do 100 mm
- material: HCS ogljikovo jeklo
- kaljeni zobje

### List za žago lisičji rep

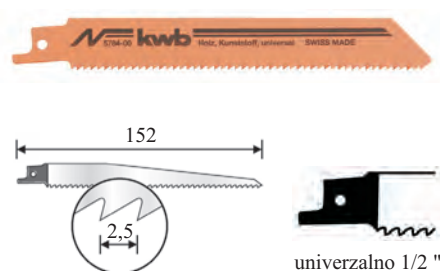

Šifra	Naziv	Pakirano kos	Pakirano
088557	Žaga vbodna S811H 152x2,5 mm KWB	2	

- za les in neželezne kovine
- material: HAS jeklo

### List za žago lisičji rep

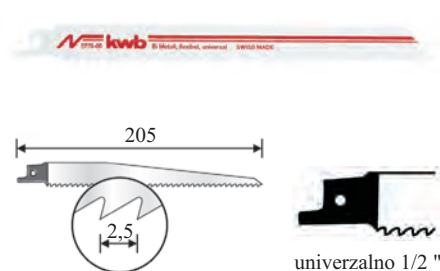

Šifra	Naziv	Pakirano kos	Pakirano
088561	Žaga vbodna S1022HF 200x2,5 mm KWB	2	

- za pločevino, cevi, profili, plastika, les, les z žebli
- material: Bi-Metal (zgradba iz dveh različnih kovin)



### List za žago lisičji rep

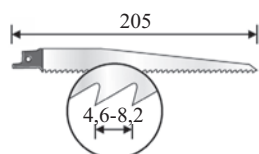

univerzalno 1/2 "

Šifra	Naziv	Pakirano kos	Pakirano
088564	5789-00 Žaga vbodna S3456XF 200x4,6-8,2 mm KWB	2	

- za kovino, cevi in profili do 18 mm, aluminij, les, les z žebli, iverne plošče do 150 mm, plastika ojačana s steklenimi vlakni do 150 mm
- material: Bi-Metal (zgradba iz dveh različnih kovin)

### List za žago lisičji rep

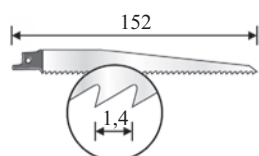

univerzalno 1/2 "

Šifra	Naziv	Pakirano kos	Pakirano
088559	5775-00 Žaga vbodna S918EF 152x1,4 mm KWB	2	

- za kovino do 150 mm, cevi in aluminijasti profili do 12 mm, jeklo, profili, pločevina, aluminij, plastika, les, les z žebli
- material: Bi-Metal (zgradba iz dveh različnih kovin)

### List za žago lisičji rep

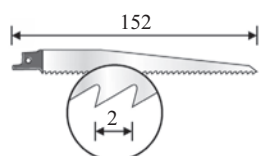

univerzalno 1/2 "

Šifra	Naziv	Pakirano kos	Pakirano
088562	5791-00 Žaga vbodna S922BF 152x1,8 mm KWB	2	

- za kovino do 150 mm, cevi in aluminijasti profili do 12 mm, jeklo, profili, pločevina, aluminij, plastika, les, les z žebli
- material: Bi-Metal (zgradba iz dveh različnih kovin)

### List za žago lisičji rep

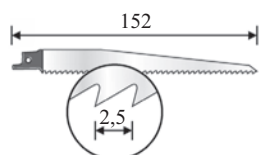

univerzalno 1/2 "

Šifra	Naziv	Pakirano kos	Pakirano
088558	5774-00 Žaga vbodna S918HF 152x2,5 mm KWB	2	

- za kovine do 150 mm, cevi in aluminijasti profili do 12 mm, aluminij, plastika, les, les z žebli
- material: Bi-Metal (zgradba iz dveh različnih kovin)
- brušeni zobje

### List za žago lisičji rep

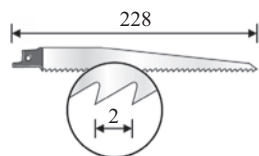

univerzalno 1/2 "

Šifra	Naziv	Pakirano kos	Pakirano
088563	5795-00 Žaga vbodna S1122BF 228x1,8 mm KWB	2	

- za kovino do 150 mm, jeklo, mehko jeklo, aluminij, neželezne kovine, cevi in aluminijasti profili do 12 mm
- material: Bi-Metal (zgradba iz dveh različnih kovin)
- brušeni zobje



### List za žago lisičji rep

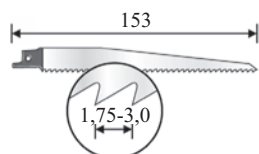

univerzalno 1/2 "

Šifra	Naziv	Pakirano kos	Pakirano
088560	5799-00 Žaga vbodna S12 150x1,75-3 mm KWB	2	

- za tanke in debele pločevine do 8 mm, cevi in profili do 100 mm
- material: Bi-Metal (zgradba iz dveh različnih kovin)
- čist rez
- brušeni zobje

### List za žago lisičji rep

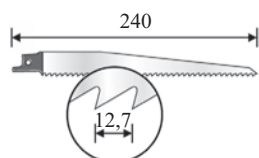

univerzalno 1/2 "

Šifra	Naziv	Pakirano kos	Pakirano
097237	5771-00 Žaga za siporeks 9x240 mm	1	

- za siporeks, opeko

### List za žago lisičji rep

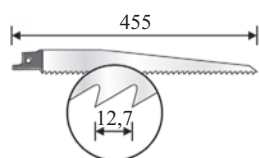

univerzalno 1/2 "

Šifra	Naziv	Pakirano kos	Pakirano
097238	5773-00 Žaga za siporeks 18x455 mm	1	

- za siporeks, opeko





### Žagin list



Šifra	Naziv	Širina mm	Globina reza mm	Pakiranje
192290	7091-94 Žagin list jap. 34x48 mm KWB	34	48	

- prihranek energije in časa 25 %
- material: krom-vanadium
- japonski zobje za čiste in hitre reze
- patentirana hitro vpenjalna glava, hitra in enostavna menjava rezil
- hitrejše odstranjevanje žaganja
- posebej primerni za baterijska orodja, ker porabijo manj energije
- za trd in mehak les, laminat, parket, plastiko, mavčne plošče



### Žagin list



Šifra	Naziv	Širina mm	Globina reza mm	Pakiranje
192856	7091-50 Žagin list 20x28 mm KWB	10	28	

- prihranek energije in časa 25 %
- material: krom-vanadium
- patentirana hitro vpenjalna glava, hitra in enostavna menjava rezil
- za čiste in hitre reze
- hitrejše odstranjevanje žaganja
- posebej primerni za baterijska orodja, ker porabijo manj energije
- za trd in mehak les, laminat, parket, plastiko, mavčne plošče

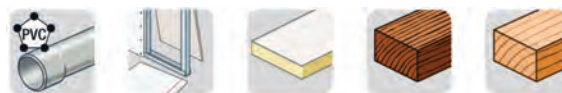

### Žagin list

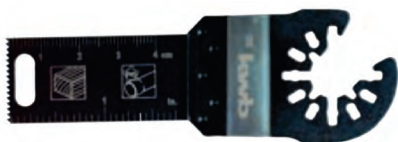

Šifra	Naziv	Širina mm	Globina reza mm	Pakiranje
192287	7091-52 Žagin list 22x48 mm KWB	22	48	

- prihranek energije in časa 25 %
- material: krom-vanadium
- patentirana hitro vpenjalna glava, hitra in enostavna menjava rezil
- za čiste in hitre reze
- hitrejše odstranjevanje žaganja
- posebej primerni za baterijska orodja, ker porabijo manj energije
- za trd in mehak les, laminat, parket, plastiko, mavčne plošče

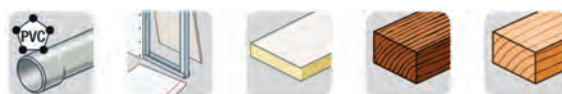



### Žagin list



Šifra	Naziv	Širina mm	Globina reza mm	Pakiranje
192289	7091-54 Žagin list 34x44 mm KWB	34	44	

- prihranek energije in časa 25 %
- material: krom-vanadium
- patentirana hitro vpenjalna glava, hitra in enostavna menjava rezil
- za čiste in hitre reze
- hitrejše odstranjevanje žaganja
- posebej primerni za baterijska orodja, ker porabijo manj energije
- za trd in mehak les, laminat, parket, plastiko, mavčne plošče

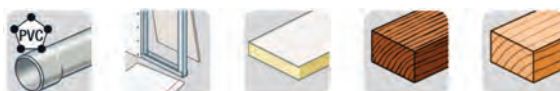

### Žagin list



Šifra	Naziv	Širina mm	Globina reza mm	Pakiranje
192284	7084-50 Rezilo KWB	2,2	52	

- prihranek energije in časa 25 %
- material: krom-vanadium
- patentirana hitro vpenjalna glava, hitra in enostavna menjava rezil
- za čiste in hitre dolge ravne reze
- posebej primerni za baterijska orodja, ker porabijo manj energije
- za les, iverne plošče, obložene iverne plošče, parket, plastiko



### Žagin list



Šifra	Naziv	Širina mm	Globina reza mm	Pakiranje
192291	7092-50 Žagin list 10x28 mm KWB	10	28	

- prihranek energije in časa 25 %
- material: Bi-Metal (zgradba iz dveh različnih kovin)
- patentirana hitro vpenjalna glava, hitra in enostavna menjava rezil
- za čiste in hitre reze
- posebej primerni za baterijska orodja, ker porabijo manj energije
- za les, prevlečen les, plastiko, steklena vlakna, pločevino do 2 mm, barvne kovine, aluminijaste profile, les z žebli





### Žagin list

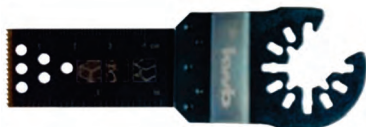

Šifra	Naziv	Širina mm	Globina reza mm	Pakiranje
192292	7092-52 Žagin list 22x48 mm KWB	22	48	

- prihranek energije in časa 25 %
- material: Bi-Metal (zgradba iz dveh različnih kovin)
- patentirana hitro vpenjalna glava, hitra in enostavna menjava rezil
- za čiste in hitre reze
- posebej primerni za baterijska orodja, ker porabijo manj energije
- za les, prevlečen les, plastiko, steklena vlakna, pločevino do 2 mm, barvne kovine, aluminijaste profile, les z žebli



### Žagin list



Šifra	Naziv	Širina mm	Globina reza mm	Pakiranje
192293	7094-50 Žagin list 87 mm	87	15	

- prihranek energije in časa 25 %
- material: Bi-Metal (zgradba iz dveh različnih kovin)
- patentirana hitro vpenjalna glava, hitra in enostavna menjava rezil
- za čiste in hitre reze
- posebej primerni za baterijska orodja, ker porabijo manj energije
- za les, prevlečen les, plastiko, steklena vlakna, pločevino do 2 mm, barvne kovine, aluminijaste profile, les z žebli



### Žagin list



Šifra	Naziv	Širina mm	Globina reza mm	Pakiranje
192266	7094-40 Žagin list Bi-metal 80 mm	80		

- material: hitrorezno jeklo HSS
- za prevlečen les debeline do 50 mm
- lahko potapljanje v material
- za les, plastiko, steklena vlakna, pločevino do 2 mm, neželezne kovine, bakrene cevi, aluminijaste cevi, žebli, mavčne plošče, profili





### Žagin list



Šifra	Naziv	Širina mm	Globina reza mm	Pakiranje
112337	7085-50 Žagin list 87 mm	80	55	

- prihranek energije in časa 25 %
- material: Bi-Metal (zgradba iz dveh različnih kovin)
- patentirana hitro vpenjalna glava
- za čiste in hitre reze
- posebej primerni za baterijska orodja, ker porabijo manj energije
- za les, plastiko, iveral, laminat, parket, steklena vlakna



### Žagin list



Šifra	Naziv	Širina mm	Globina reza mm	Pakiranje
192293	7084-60 Rezilo za ploščice KWB	2,2	52	

- prihranek energije in časa 25 %
- material: HM
- patentirana hitro vpenjalna glava, hitra in enostavna menjava
- posebej primerni za baterijska orodja, ker porabijo manj energije
- posebej primeren za zamenjavo keramične ploščice
- za keramične ploščice, siporeks



### Univerzalni adapter



Šifra	Naziv	Pakiranje
192286	7087-00 Adapter univerzalni KWB	

Univerzalni adapter je vsestranski dodatek za multifunkcijska orodja. Za Bosch PMF 180 E, GOP 10,8 V-LI, EINHELL RT-MG 200 E RED, RT-MG 108 Li RED, BTMG 220 E, BT-MG 180, DREMEL Multi-Max, ERGOTOOLS Plattfield E-MG 250 E, LUX, ORODJA AMF 12 Li, Mac Alister MMT108, PARKSIDE, FEIN Multimaster Ø 10 mm, Rockwell Works Sonicrafter, Craftsman Multi-Tool, MASTERCRAFT Multi-Cutter



### Žagini listi - 7 delni set



Šifra	Naziv	Vsebina naziv	Širina reza mm	Globina reza mm	Pakiranje
192283	7080-00 Orodje multi 7 del KWB				
		7091-94	34	43	
		7091-50	10	28	
		7091-52	22	48	
		7091-54	34	44	
		7092-52	22	48	
		7094-50	ø 87	15	
		7084-50	2,0	52	

### Žagini listi za Multifunkcijska orodja

- prihranek energije in časa 25 %
- lažje delo zahvaljujoč novemu inovativnemu dizajnu
- manjša poraba energije, daljši čas delovanja baterije
- manj napora za baterijska orodja
- hitrejše žaganje in odstranjevanje prahu
- patentirana hitro vpenjalna glava, hitra in enostavna menjava rezil
- ti prihranki so realizirani z medsebojnim delovanjem mnogih inovativnih dejavnikov in patentiranim razvojem
- patentirani utori za boljše in hitrejše delovanje in patentirana hitro vpenjalna glava
- posebej primerni za baterijska orodja, ker porabijo manj energije
- uporabno tudi za vsa ostala električna orodja
- za vse namene uporabe za les, kovino in plastiko



AEG POWERTOOLS

### Žagini listi - za AEG OmniPro



Šifra Naziv

155841 4932-4303-14 Komplet rezil za Omnipro

#### - 9 delni set vsebuje:

- 2 x Bi-Metal potopno rezilo
- 2 x potopno rezilo 28 mm
- 2 x potopno rezilo 9 mm
- 1 x potopno rezilo
- 1 x rezilo za fugirno maso
- 1 x strgalo

## Diamantna rezalka



Šifra	Naziv	Premer (ø) mm	Debelina mm	Luknja mm
192294	7211-40 Disk diamantni 115x22x1,2 mm KWB	115	1,2	22
192296	7245-40 Disk diamantni 125x22x1,2 mm KWB	125	1,2	22

- prihranek energije in časa 20 %
- zelo tanko rezilo 1,2 mm, turbo oblika
- profesionalno, enostavno in hitro rezanje
- dolga življenjska doba
- za vse običajne kotne brusilnike z obodno hitrostjo 80 m/s
- posebej primerna za baterijske rezalke, ker porabijo manj energije
- za granit, marmor, beton, keramiko, ploščice, lončevino, naravni in umetni kamen





### Rezalka za Inox



Šifra	Naziv	Premer (ø) mm	Debelina mm	Luknja min
148154	Rezalka za Inox A60TZ 115x1x22,23	115	1,0	22,23
148188	Rezalka za Inox A60TZ 115x1x22,23 pak. 10 kos	115	1,0	22,23
148157	Rezalka za Inox A60TZ 125x1x22,23	125	1,0	22,23
148189	Rezalka za Inox A60TZ 125x1x22,23 pak. 10 kos	125	1,0	22,23
148161	Rezalka za Inox A46TZ 180x1,6	180	1,6	22,23
148180	Rezalka za Inox A46TZ 230x1,9x22,23	230	1,9	22,23

- za inox
- za vse običajne kotne brusilnike z obodno hitrostjo 80 m/s

### Rezalka za kovino



Šifra	Naziv	Premer (ø) mm	Debelina mm	Luknja min
148067	Rezalka za kovino 115 mm A24E	115	2,5	22,23
148096	Rezalka za kovino 125 mm A24E	125	2,5	22,23
148068	Rezalka za kovino 180 mm A24E	180	3	22,23
148069	Rezalka za kovino 230 mm A24E	230	3	22,23

- za kovino
- za vse običajne kotne brusilnike z obodno hitrostjo 80 m/s

### Rezalka za kamen



Šifra	Naziv	Premer (ø) mm	Debelina mm	Luknja min
148075	Rezalka za kamen 115 mm C24E	115	2,5	22,23
148088	Rezalka za kamen 125 mm C24E	125	2,5	22,23
148076	Rezalka za kamen 180 mm C24E	180	3	22,23
148077	Rezalka za kamen 230 mm C24R	230	3	22,23

- za kamen
- za vse običajne kotne brusilnike z obodno hitrostjo 80 m/s

### Brusna plošča za kovino



Šifra	Naziv	Premer (ø) mm	Debelina mm	Luknja min
148080	Brusna plošča 115x6 A24E	115	6	22,23
148091	Brusna plošča 125x6 A24E	125	6	22,23
148081	Brusna plošča 180x6 A24E	180	6	22,23
148082	Brusna plošča 230x6 A24E	230	9	22,23

- za kovino
- za vse običajne kotne brusilnike z obodno hitrostjo 80 m/s



### Lamelni brusni krožnik



Šifra	Naziv	Premer (ø) mm	Vrtljaji 1/min
148623	Brusni krožnik lamelni 115 624 gr. 40	115	13300
148624	Brusni krožnik lamelni 115 624 gr. 60	115	13300
148598	Brusni krožnik lamelni 115 624 gr. 80	115	13300
148599	Brusni krožnik lamelni 115 624 gr. 120	115	13300

- za inox, jeklo
- izvedba: ukrivljena 12°
- vezivo: umetna smola
- krožnik: tkanina iz steklenih vlaken
- zrna: cirkonij
- luknja: ø 22,23 mm



### Lamelni brusni krožnik



Šifra	Naziv	Premer (ø) mm	Vrtljaji 1/min
148600	Brusni krožnik lamelni 115 626 gr. 40	115	13300
148601	Brusni krožnik lamelni 115 626 gr. 60	115	13300
148602	Brusni krožnik lamelni 115 626 gr. 80	115	13300
148603	Brusni krožnik lamelni 115 626 gr. 120	115	13300

- za inox, jeklo
- izvedba: ukrivljena 6°
- vezivo: umetna smola
- krožnik: tkanina iz steklenih vlaken
- zrna: cirkonij
- luknja: ø 22,23 mm



### Lamelni brusni krožnik



Šifra	Naziv	Premer (ø) mm	Vrtljaji 1/min
148186	Brusni krožnik lamelni 115 619 gr. 40	115	13300
148187	Brusni krožnik lamelni 115 619 gr. 60	115	13300
148149	Brusni krožnik lamelni 115 619 gr. 80	115	13300

- za kovino
- izvedba: ukrivljena
- vezivo: umetna smola
- krožnik: plastika ojačana s steklenimi vlakni
- zrna: cirkonij
- luknja: ø 22,23 mm

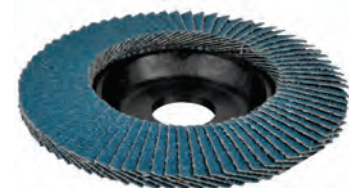

### Lamelni brusni krožnik



Šifra	Naziv	Premer (ø) mm	Vrtljaji 1/min
148605	Brusni krožnik lamelni 115 314 gr. 40	115	13300
148606	Brusni krožnik lamelni 115 314 gr. 60	115	13300
148607	Brusni krožnik lamelni 115 314 gr. 80	115	13300
148608	Brusni krožnik lamelni 115 314 gr. 120	115	13300

- za jeklo, neželezne kovine
- izvedba: ukrivljena
- vezivo: umetna smola
- krožnik: tkanina iz steklenih vlaken
- zrna: aluminijev oksid
- luknja: ø 22,23 mm







### Brusni papir

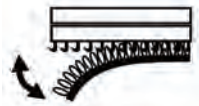
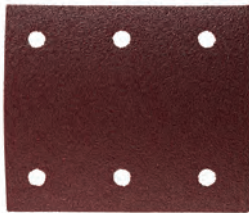

Šifra	Naziv	Dolžina mm	Širina mm	Granulacija	Pakirano kos
088407	8180-04 Papir brusni 40/115x100 mm	115	100	40	5
088408	8180-08 Papir brusni 80/115x100 mm	115	100	80	5
088409	8180-12 Papir brusni 120/115x100 mm	115	100	120	5
088410	8180-18 Papir brusni 180/115x100 mm	115	100	180	5
088411	8180-24 Papir brusni 240/115x100 mm	115	100	240	5

- za les in kovino
- zrna: aluminijev oksid
- samolepilen
- za vibracijske brusilnike z odsesavanjem

### Brusni papir

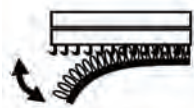

Šifra	Naziv	Dolžina mm	Širina mm	Granulacija	Pakirano kos
088397	8184-04 Papir brusni 40/80x133 mm	133	80	40	5
088398	8184-08 Papir brusni 80/80x133 mm	133	80	80	5
088399	8184-12 Papir brusni 120/80x133 mm	133	80	120	5
088400	8184-18 Papir brusni 180/80x133 mm	133	80	180	5

- za les in kovino
- zrna: aluminijev oksid
- samolepilen
- za vibracijske brusilnike z odsesavanjem

za brusilnike:  
**AEG: FS2**

### Brusni papir

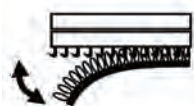

Šifra	Naziv	Dolžina mm	Širina mm	Granulacija	Pakirano kos
088402	8183-04 Papir brusni 40/93x185 mm	185	93	40	5
088403	8183-08 Papir brusni 80/93x185 mm	185	93	80	5
088404	8183-12 Papir brusni 120/93x185 mm	185	93	120	5
088405	8183-18 Papir brusni 180/93x185 mm	185	93	180	5
088406	8183-24 Papir brusni 20/93x185 mm	185	93	240	5

- za les in kovino
- zrna: aluminijev oksid
- samolepilen
- za vibracijske brusilnike z odsesavanjem

za brusilnike:  
**AEG: VS/E230, VS/E260**  
**Ferm: PSM 1024**

### Brusni papir

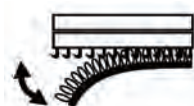
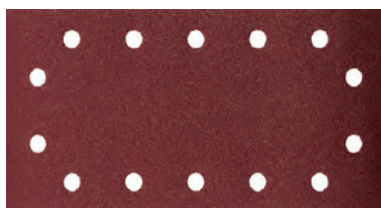

Šifra	Naziv	Dolžina mm	Širina mm	Granulacija	Pakirano kos
088412	8189-04 Papir brusni 40/115x230 mm	230	115	40	5
088413	8189-08 Papir brusni 80/115x230 mm	230	115	80	5
088414	8189-12 Papir brusni 120/115x230 mm	230	115	120	5
088415	8189-18 Papir brusni 180/115x230 mm	230	115	180	5
088416	8189-24 Papir brusni 240/115x230 mm	230	115	240	5

- za les in kovino
- zrna: aluminijev oksid
- samolepilen
- za vibracijske brusilnike z odsesavanjem



### Brusni papir



Šifra	Naziv	Dolžina mm	Širina mm	Granulacija	Pakirano kos
088382	8182-04 Papir brusni 40/93x230 mm	230	93	40	10
088383	8182-08 Papir brusni 80/93x230 mm	230	93	80	10
088384	8182-12 Papir brusni 120/93x230 mm	230	93	120	10
088386	8182-24 Papir brusni 240/93x230 mm	230	93	240	10

- za les in kovino
- zrna: aluminijev oksid
- univerzalno vpetje
- za vibracijske brusilnike z odsesavanjem

### Brusni papir



Šifra	Naziv	Dolžina mm	Širina mm	Granulacija	Pakirano kos
088377	8181-04 Papir brusni 40/93x230 mm	230	93	40	10
088378	8181-08 Papir brusni 80/93x230 mm	230	93	80	10
088379	8181-12 Papir brusni 120/93x230 mm	230	93	120	10
088380	8181-20 Papir brusni 180/93x230 mm	230	93	180	10
088381	8181-24 Papir brusni 240/93x230 mm	230	93	240	10

- za les in kovino
- zrna: aluminijev oksid
- univerzalno vpetje
- za vibracijske brusilnike z odsesavanjem

za brusilnike:  
**AEG:** VS 130, VSE 130, VS 230, VSSE 260, [VSS 260](#)

### Brusni papir



Šifra	Naziv	Dolžina mm	Širina mm	Granulacija	Pakirano kos
088387	8187-04 Papir brusni 40/115x280 mm	280	115	40	10
088388	8187-08 Papir brusni 80/115x280 mm	280	115	80	10
088389	8187-12 Papir brusni 120/115x280 mm	280	115	120	10
088390	8187-20 Papir brusni 180/115x280 mm	280	115	180	10
088391	8187-24 Papir brusni 240/115x280 mm	280	115	240	10

- za les in kovino
- zrna: aluminijev oksid
- univerzalno vpetje
- za vibracijske brusilnike z odsesavanjem

za brusilnike:  
**AEG:** VS 14, VS 20, VSE 20, VSS 20, VSSE 20, VS 250, VSE 250, VSS 280, VSSE 280

### Brusni papir

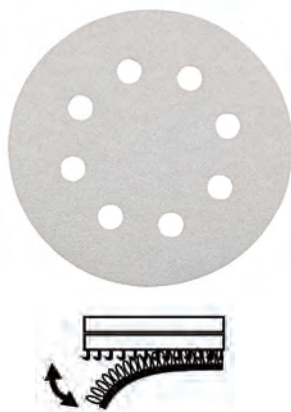

Šifra	Naziv	Premer (ø) mm	Granulacija	Pakirano kos
088360	4959-04 Papir brusni 40 fi 125 mm	125	40	6
088361	4959-06 Papir brusni 60 fi 125 mm	125	60	6
088362	4959-08 Papir brusni 80 fi 125 mm	125	80	6
088363	4959-12 Papir brusni 120 fi 125 mm	125	120	6

- za les in lak
- zrna: aluminijev oksid
- samolepilen
- za rotacijske brusilnike z odsesavanjem

za brusilnike:  
**AEG:** EX 400, EX 450, EXE 400, EXE 460 (125)  
**Ferm:** ESM 1007



### Brusni papir

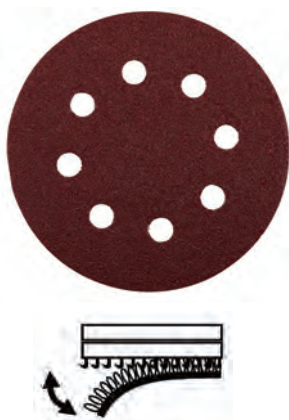

Šifra	Naziv	Premer (ø) mm	Granulacija	Pakirano kos
088344	4918-04 Papir brusni 40 fi 115 mm	115	40	6
088345	4918-06 Papir brusni 60 fi 115 mm	115	60	6
088346	4918-08 Papir brusni 80 fi 115 mm	115	80	6
088347	4918-12 Papir brusni 120 fi 115 mm	115	120	6
088348	4918-18 Papir brusni 180 fi 115 mm	115	180	6
088349	4918-24 Papir brusni 240 fi 115 mm	115	240	6

- za les in kovino
- zrna: aluminijev oksid
- samolepilen
- za rotacijske brusilnike z odsesavanjem

### Brusni papir

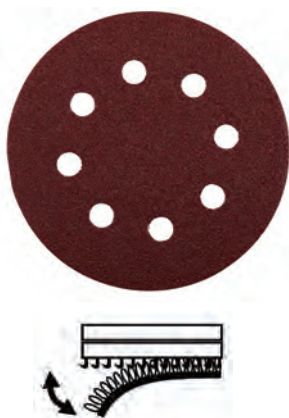

Šifra	Naziv	Premer (ø) mm	Granulacija	Pakirano kos
088352	4919-04 Papir brusni 40 fi 125 mm	125	40	6
088353	4919-06 Papir brusni 60 fi 125 mm	125	60	6
088354	4919-08 Papir brusni 80 fi 125 mm	125	80	6
088355	4919-12 Papir brusni 120 fi 125 mm	125	120	6
088356	4919-18 Papir brusni 180 fi 125 mm	125	180	6
088357	4919-24 Papir brusni 240 fi 125 mm	125	240	6
088358	4919-32 Papir brusni 320 fi 125 mm	125	320	6

- za les in kovino
- zrna: aluminijev oksid
- samolepilen
- za rotacijske brusilnike z odsesavanjem

za brusilnike:  
**AEG:** EX 400, EX 450, EXE 400, EXE 460 (125), [EX 125 E](#), [EX 125 E EX 125 ES](#)  
**Ferm:** ESM 1007

### Brusni papir

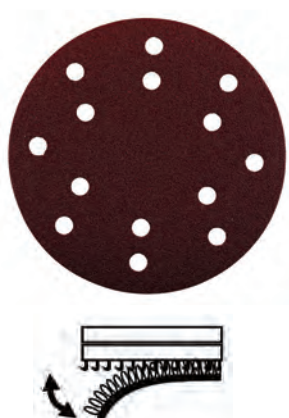

Šifra	Naziv	Premer (ø) mm	Granulacija	Pakirano kos
088364	4920-04 Papir brusni 40 fi 150 mm	150	40	6
088365	4920-06 Papir brusni 60 fi 150 mm	150	60	6
088366	4920-08 Papir brusni 80 fi 150 mm	150	80	6
088367	4920-12 Papir brusni 120 fi 150 mm	150	120	6
088368	4920-18 Papir brusni 180 fi 150 mm	150	180	6
088369	4920-24 Papir brusni 240 fi 150 mm	150	240	6

- za les in kovino
- zrna: aluminijev oksid
- samolepilen
- za rotacijske brusilnike z odsesavanjem

za brusilnike:  
**AEG:** EXE 460, ROS 150 E, [EX 150 E](#), [EX 150 E EX 150 ES](#)



### Brusni papir PS 22 K



Šifra	Naziv	Premer (ø) mm	Granulacija	Luknje (ø) mm
148700	Krožnik polirni (8 lukenj) fi 125 mm gr. 40	125	40	10
148701	Krožnik polirni (8 lukenj) fi 125 mm gr. 60	125	60	10
148702	Krožnik polirni (8 lukenj) fi 125 mm gr. 80	125	80	10
148703	Krožnik polirni (8 lukenj) fi 125 mm gr. 100	125	100	10
148704	Krožnik polirni (8 lukenj) fi 125 mm gr. 120	125	120	10
148705	Krožnik polirni (8 lukenj) fi 125 mm gr. 150	125	150	10
148706	Krožnik polirni (8 lukenj) fi 125 mm gr. 180	125	180	10
148707	Krožnik polirni (8 lukenj) fi 125 mm gr. 220	125	220	10
148708	Krožnik polirni (8 lukenj) fi 125 mm gr. 240	125	240	10
148709	Krožnik polirni (8 lukenj) fi 125 mm gr. 280	125	280	10
148710	Krožnik polirni (8 lukenj) fi 125 mm gr. 320	125	320	10
148711	Krožnik polirni (8 lukenj) fi 125 mm gr. 400	125	400	10
148712	Krožnik polirni (8 lukenj) fi 125 mm gr. 500	125	500	10
148738	Krožnik polirni (8 lukenj) fi 125 mm gr. 600	125	600	10

- za les in kovino
- zrna: aluminijev oksid
- vezivo: umetna smola
- podlaga: papir (gramatura cca 250 g/m<sup>2</sup>)
- način posipa: polodprt

za brusilnike:  
**AEG: EX 125 ES**

### Brusni papir PS 22 K

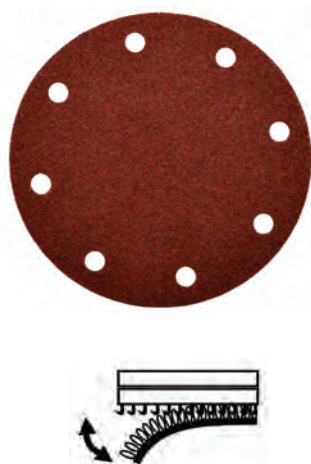

Šifra	Naziv	Premer (ø) mm	Granulacija	Luknje (ø) mm
148724	Krožnik polirni (8 lukenj) fi 152 mm gr. 40	152	40	10
148723	Krožnik polirni (8 lukenj) fi 152 mm gr. 60	152	60	10
148722	Krožnik polirni (8 lukenj) fi 152 mm gr. 80	152	80	10
148721	Krožnik polirni (8 lukenj) fi 152 mm gr. 100	152	100	10
148720	Krožnik polirni (8 lukenj) fi 152 mm gr. 120	152	120	10
148719	Krožnik polirni (8 lukenj) fi 152 mm gr. 150	152	150	10
148718	Krožnik polirni (8 lukenj) fi 152 mm gr. 180	152	180	10
148717	Krožnik polirni (8 lukenj) fi 152 mm gr. 220	152	220	10
148716	Krožnik polirni (8 lukenj) fi 152 mm gr. 240	152	240	10
148715	Krožnik polirni (8 lukenj) fi 152 mm gr. 280	152	280	10
148714	Krožnik polirni (8 lukenj) fi 152 mm gr. 320	152	320	10
148713	Krožnik polirni (8 lukenj) fi 152 mm gr. 400	152	400	10
148761	Krožnik polirni (8 lukenj) fi 152 mm gr. 1000	152	1000	10
148760	Krožnik polirni (8 lukenj) fi 152 mm gr. 1500	152	1500	10

- za les in kovino
- zrna: aluminijev oksid
- vezivo: umetna smola
- podlaga: papir (gramatura cca 250 g/m<sup>2</sup>)
- način posipa: polodprt



### Brusni papir PS 22 K

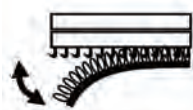

Šifra	Naziv	Premer (ø) mm	Granulacija	Luknje (ø) mm
148728	Krožnik polirni (6 lukenj) fi 152 mm gr. 40	152	40	10
148725	Krožnik polirni (6 lukenj) fi 152 mm gr. 60	152	60	10
148729	Krožnik polirni (6 lukenj) fi 152 mm gr. 80	152	80	10
148730	Krožnik polirni (6 lukenj) fi 152 mm gr. 100	152	100	10
148726	Krožnik polirni (6 lukenj) fi 152 mm gr. 120	152	120	10
148731	Krožnik polirni (6 lukenj) fi 152 mm gr. 150	152	150	10
148727	Krožnik polirni (6 lukenj) fi 152 mm gr. 180	152	180	10
148732	Krožnik polirni (6 lukenj) fi 152 mm gr. 220	152	220	10
148733	Krožnik polirni (6 lukenj) fi 152 mm gr. 240	152	240	10
148734	Krožnik polirni (6 lukenj) fi 152 mm gr. 280	152	280	10
148735	Krožnik polirni (6 lukenj) fi 152 mm gr. 320	152	320	10
148736	Krožnik polirni (6 lukenj) fi 152 mm gr. 400	152	400	10
148739	Krožnik polirni (6 lukenj) fi 152 mm gr. 500	152	500	10
148737	Krožnik polirni (6 lukenj) fi 152 mm gr. 600	152	600	10
148758	Krožnik polirni (6 lukenj) fi 152 mm gr. 1000	152	1000	10
148759	Krožnik polirni (6 lukenj) fi 152 mm gr. 1500	152	1500	10

- za les in kovino
- zrna: aluminijev oksid
- vezivo: umetna smola
- podlaga: papir (gramatura cca 250 g/m<sup>2</sup>)
- način posipa: polodprt

### Brusni papir PS 22 K

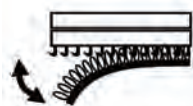

Šifra	Naziv	Premer (ø) mm	Granulacija
148753	Krožnik polirni fi 150 mm gr. 40	150	40
148740	Krožnik polirni fi 150 mm gr. 60	150	60
148741	Krožnik polirni fi 150 mm gr. 80	150	80
148742	Krožnik polirni fi 150 mm gr. 100	150	100
148756	Krožnik polirni fi 150 mm gr. 120	150	120
148748	Krožnik polirni fi 150 mm gr. 150	150	150
148755	Krožnik polirni fi 150 mm gr. 320	150	320

- za les in kovino
- zrna: aluminijev oksid
- vezivo: umetna smola
- podlaga: papir (gramatura cca 250 g/m<sup>2</sup>)
- način posipa: polodprt

za brusilnike:  
**AEG: EXE 460, ROS 150 E,**  
**EX 150 E**



### Brusni papir PS 22 K

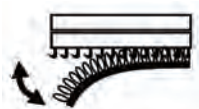

Šifra	Naziv	Premer (ø) mm	Granulacija
148743	Krožnik polirni fi 180 mm gr. 40	180	40
148744	Krožnik polirni fi 180 mm gr. 60	180	60
148745	Krožnik polirni fi 180 mm gr. 80	180	80
148746	Krožnik polirni fi 180 mm gr. 100	180	100
148747	Krožnik polirni fi 180 mm gr. 120	180	120
148749	Krožnik polirni fi 180 mm gr. 150	180	150
148750	Krožnik polirni fi 180 mm gr. 180	180	180
148752	Krožnik polirni fi 180 mm gr. 240	180	240
148751	Krožnik polirni fi 180 mm gr. 320	180	320

- za les in kovino
- zrna: aluminijev oksid
- vezivo: umetna smola
- podlaga: papir (gramatura cca 250 g/m<sup>2</sup>)
- način posipa: polodprt

### Brusni krožnik CS 561



Šifra	Naziv	Premer (ø) mm	Granulacija	Luknja (ø) mm
148083	Brusni krožnik 115 561 gr. 36	115	36	22
148084	Brusni krožnik 115 561 gr. 60	115	60	22
148085	Brusni krožnik 115 561 gr. 80	115	80	22
148158	Brusni krožnik 115 561 gr. 150	115	150	22
148159	Brusni krožnik 115 561 gr. 180	115	180	22
148160	Brusni krožnik 115 561 gr. 240	115	240	22
148095	Brusni krožnik 180 561 gr. 36	180	36	22
148087	Brusni krožnik 180 561 gr. 60	180	60	22
148089	Brusni krožnik 180 561 gr. 80	180	80	22
148090	Brusni krožnik 180 561 gr. 100	180	100	22

- za jeklo, neželezne kovine
- zrna: aluminijev oksid
- vezivo: umetna smola
- podlaga: fiber
- za uporabo na kotnih brusilkah



### Brusni papir



Šifra	Naziv	Dolžina m	Širina mm	Granulacija
088466	8178-04 Papir brusni 5 m gr. 40	5	115	40
088467	8178-06 Papir brusni 5 m gr. 60	5	115	60
088468	8178-08 Papir brusni 5 m gr. 80	5	115	80
088469	8178-12 Papir brusni 5 m gr. 120	5	115	120
088470	8178-18 Papir brusni 5 m gr. 180	5	115	180
088471	8178-24 Papir brusni 5 m gr. 240	5	115	240

- za les in kovino
- zrna: aluminijev oksid
- vezan s fenolno smolo
- ojačana podlaga
- v kolutu



### Brusni papir

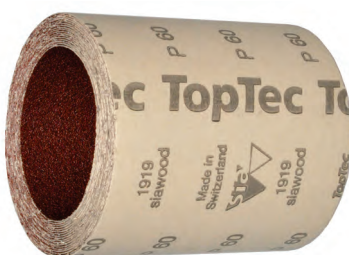

Šifra	Naziv	Dolžina m	Širina mm	Granulacija
148420	Brusni papir SIA gr. 40 pak. 10 m	10	120	40
148401	Brusni papir SIA gr. 60 pak. 5 m	5	120	60
148400	Brusni papir SIA gr. 60 pak. 10 m	10	120	60
148403	Brusni papir SIA gr. 80 pak. 5 m	5	120	80
148402	Brusni papir SIA gr. 80 pak. 10 m	10	120	80
148405	Brusni papir SIA gr. 100 pak. 5 m	5	120	100
148404	Brusni papir SIA gr. 100 pak. 10 m	10	120	100
148407	Brusni papir SIA gr. 120 pak. 5 m	5	120	120
148406	Brusni papir SIA gr. 120 pak. 10 m	10	120	120
148408	Brusni papir SIA gr. 150 pak. 5 m	5	120	150
148409	Brusni papir SIA gr. 150 pak. 10 m	10	120	150
148421	Brusni papir SIA gr. 180 pak. 5 m	5	120	180
148422	Brusni papir SIA gr. 220 pak. 10 m	10	120	220

### Brusno platno



Šifra	Naziv	Dolžina m	Širina mm	Granulacija
148411	Brusno platno SIA gr. 60 pak. 5 m	5	120	60
148410	Brusno platno SIA gr. 60 pak. 10 m	10	120	60
148413	Brusno platno SIA gr. 80 pak. 5 m	5	120	80
148412	Brusno platno SIA gr. 80 pak. 10 m	10	120	80
148415	Brusno platno SIA gr. 100 pak. 5 m	5	120	100
148414	Brusno platno SIA gr. 100 pak. 10 m	10	120	100
148417	Brusno platno SIA gr. 120 pak. 5 m	5	120	120
148416	Brusno platno SIA gr. 120 pak. 10 m	10	120	120
148419	Brusno platno SIA gr. 150 pak. 5 m	5	120	150
148418	Brusno platno SIA gr. 150 pak. 10 m	10	120	150



### Brusni trak

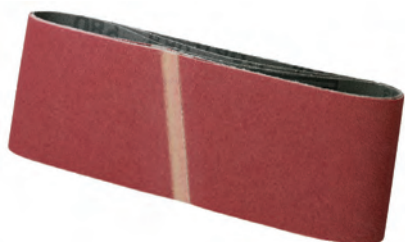

Šifra	Naziv	Dolžina mm	Širina mm	Granulacija	Pakirano kos
088417	9114-04 Papir brusni 40/65/410 mm	410	65	40	3
088418	9114-06 Papir brusni 60/65/410 mm	410	65	60	3
088419	9114-08 Papir brusni 80/65/410 mm	410	65	80	3
088420	9114-10 Papir brusni 100/65/410 mm	410	65	100	3
088422	9114-15 Papir brusni 150/65/410 mm	410	65	150	3

- za les in kovino
- zrna: aluminijev oksid
- podlaga: elastična bombažna tkanina

za brusilnike:  
**AEG:** HBS 65, HBSE 65

### Brusni trak

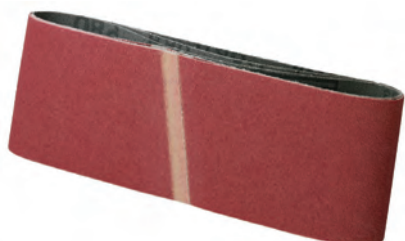

Šifra	Naziv	Dolžina mm	Širina mm	Granulacija	Pakirano kos
088430	9123-04 Papir brusni 40/75x510 mm	510	75	40	3
088431	9123-06 Papir brusni 60/75x510 mm	510	75	60	3
088432	9123-08 Papir brusni 80/75x510 mm	510	75	80	3
088433	9123-10 Papir brusni 100/75x510 mm	510	75	100	3
088434	9123-12 Papir brusni 120/75x510 mm	510	75	120	3
088435	9123-15 Papir brusni 150/75x510 mm	510	75	150	3

- za les in kovino
- zrna: aluminijev oksid
- podlaga: elastična bombažna tkanina

### Brusni trak

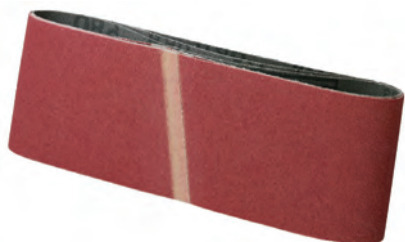

Šifra	Naziv	Dolžina mm	Širina mm	Granulacija	Pakirano kos
088436	9125-02 Papir brusni 24/75x533 mm	533	75	24	3
088437	9125-04 Papir brusni 40/75x533 mm	533	75	40	3
088438	9125-06 Papir brusni 60/75x533 mm	533	75	60	3
088439	9125-08 Papir brusni 80/75x533 mm	533	75	80	3
088440	9125-10 Papir brusni 100/75x533 mm	533	75	100	3
088441	9125-12 Papir brusni 120/75x533 mm	533	75	120	3
088442	9125-15 Papir brusni 150/75x533 mm	533	75	150	3

- za les in kovino
- zrna: aluminijev oksid
- podlaga: elastična bombažna tkanina

za brusilnike:  
**AEG:** HBSE 75 S, HBSE 600,  
 RBSE 75 AE  
**Ferm:** BSM 1021, BSM 1022





### Brusni trak

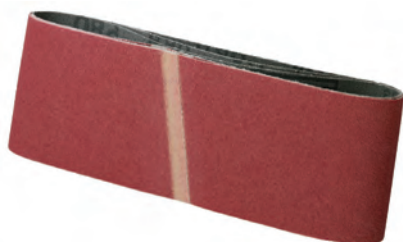

Šifra	Naziv	Dolžina mm	Širina mm	Granulacija	Pakirano kos
088444	9144-04 Papir brusni 40/100x560 mm	560	100	40	3
088445	9144-06 Papir brusni 60/100x560 mm	560	100	60	3
088446	9144-08 Papir brusni 80/100x560 mm	560	100	80	3
088447	9144-10 Papir brusni 100/100x560 mm	560	100	100	3
088449	9144-15 Papir brusni 150/100x560 mm	560	100	150	3

- za les in kovino
- zrna: aluminijev oksid
- podlaga: elastična bombažna tkanina

za brusilnike:  
**AEG:** HBS 100, HBSE 100,  
 BBS 1100, BBSE 1100

### Brusni trak

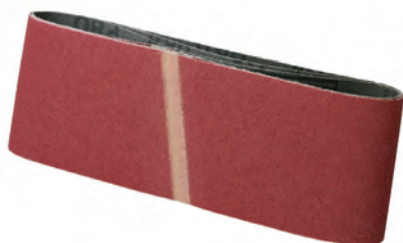

Šifra	Naziv	Dolžina mm	Širina mm	Granulacija	Pakirano kos
088450	9145-04 Papir brusni 40/100x610 mm	610	100	40	3
088451	9145-06 Papir brusni 60/100x610 mm	610	100	60	3
088452	9145-08 Papir brusni 80/100x610 mm	610	100	80	3
088453	9145-10 Papir brusni 100/100x610 mm	610	100	100	3
088455	9145-15 Papir brusni 150/100x610 mm	610	100	150	3

- za les in kovino
- zrna: aluminijev oksid
- podlaga: elastična bombažna tkanina

### Brusni trak

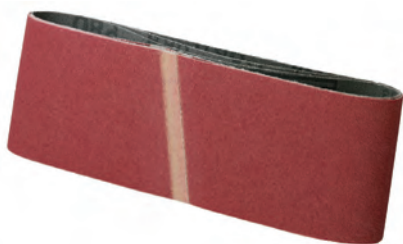

Šifra	Naziv	Dolžina mm	Širina mm	Granulacija	Pakirano kos
088456	9147-04 Papir brusni 40/105x620 mm	620	105	40	3
088457	9147-06 Papir brusni 60/105x620 mm	620	105	60	3
088458	9147-08 Papir brusni 80/105x620 mm	620	105	80	3
088459	9147-10 Papir brusni 100/105x620 mm	620	105	100	3
088460	9147-12 Papir brusni 120/105x620 mm	620	105	120	3
088461	9147-15 Papir brusni 150/105x620 mm	620	105	150	3

- za les in kovino
- zrna: aluminijev oksid
- podlaga: elastična bombažna tkanina

za brusilnike:  
**AEG:** HBS 2-110, HBS 10/E

### Brusni trak

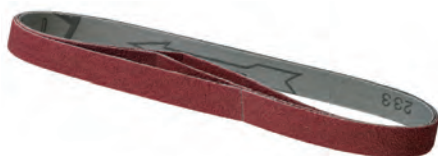

Šifra	Naziv	Dolžina mm	Širina mm	Granulacija	Pakirano kos
088462	9105-04 Papir brusni 40/13x457 mm	457	13	40	3
088463	9105-06 Papir brusni 60/13x457 mm	457	13	60	3
088464	9105-10 Papir brusni 100/13x457 mm	457	13	100	3

- za les in kovino
- zrna: aluminijev oksid
- podlaga: elastična bombažna tkanina



### Brusni trak



Šifra	Naziv	Dolžina mm	Širina mm	Granulacija
148574	Brusni trak 75x457 gr. 40 LS309X	457	75	40
148575	Brusni trak 75x457 gr. 60 LS309X	457	75	60
148576	Brusni trak 75x457 gr. 80 LS309X	457	75	80
148578	Brusni trak 75x457 gr. 100 LS309X	457	75	100
148579	Brusni trak 75x457 gr. 120 LS309X	457	75	120
148580	Brusni trak 75x457 gr. 150 LS309X	457	75	150
148313	Brusni trak 75x480 gr. 60 LS309X	480	75	60
148237	Brusni trak 75x480 gr. 80 LS309X	480	75	80
148238	Brusni trak 75x480 gr. 100 LS309X	480	75	100
148268	Brusni trak 75x480 gr. 120 LS309X	480	75	120
148568	Brusni trak 75x508 gr. 40 LS309X	508	75	40
148569	Brusni trak 75x508 gr. 60 LS309X	508	75	60
148570	Brusni trak 75x508 gr. 80 LS309X	508	75	80
148571	Brusni trak 75x508 gr. 100 LS309X	508	75	100
148572	Brusni trak 75x508 gr. 120 LS309X	508	75	120
148573	Brusni trak 75x508 gr. 150 LS309X	508	75	150
148562	Brusni trak 75x533 gr. 40 LS309X	533	75	40
148563	Brusni trak 75x533 gr. 60 LS309X	533	75	60
148564	Brusni trak 75x533 gr. 80 LS309X	533	75	80
148565	Brusni trak 75x533 gr. 100 LS309X	533	75	100
148566	Brusni trak 75x533 gr. 120 LS309X	533	75	120
148567	Brusni trak 75x533 gr. 150 LS309X	533	75	150
148549	Brusni trak 75x533 gr. 180 LS309X	533	75	180
148591	Brusni trak 100x533 gr. 40 LS309X	533	100	40
148593	Brusni trak 100x533 gr. 60 LS309X	533	100	60
148594	Brusni trak 100x533 gr. 80 LS309X	533	100	80
148595	Brusni trak 100x533 gr. 100 LS309X	533	100	100
148596	Brusni trak 100x533 gr. 120 LS309X	533	100	120
148597	Brusni trak 100x533 gr. 150 LS309X	533	100	150
148590	Brusni trak 100x533 gr. 180 LS309X	533	100	180
148556	Brusni trak 100x560 gr. 40 LS309X	560	100	40
148557	Brusni trak 100x560 gr. 60 LS309X	560	100	60
148558	Brusni trak 100x560 gr. 80 LS309X	560	100	80
148559	Brusni trak 100x560 gr. 100 LS309X	560	100	100
148560	Brusni trak 100x560 gr. 120 LS309X	560	100	120
148561	Brusni trak 100x560 gr. 150 LS309X	560	100	150
148604	Brusni trak 100x560 gr. 180 LS309X	560	100	180
148550	Brusni trak 100x610 gr. 40 LS309X	610	100	40
148551	Brusni trak 100x610 gr. 60 LS309X	610	100	60
148552	Brusni trak 100x610 gr. 80 LS309X	610	100	80
148553	Brusni trak 100x610 gr. 100 LS309X	610	100	100
148554	Brusni trak 100x610 gr. 120 LS309X	610	100	120
148555	Brusni trak 100x610 gr. 150 LS309X	610	100	150
148583	Brusni trak 100x610 gr. 180 LS309X	610	100	180

- za les in kovino

- zrna: aluminijev oksid, podlaga: tkanina



### Brusni trak



Šifra	Naziv	Dolžina mm	Širina mm	Granulacija
148205	Brusni papir 150x2510 PA SIA gr. 40	2510	150	40
148204	Brusni papir 150x2510 PA SIA gr. 60	2510	150	60
148120	Brusni papir 150x2510 PA SIA gr. 80	2510	150	80
148119	Brusni papir 150x2510 PA SIA gr. 100	2510	150	100
148118	Brusni papir 150x2510 PA SIA gr. 120	2510	150	120
148117	Brusni papir 150x2510 PA SIA gr. 150	2510	150	150
148121	Brusni papir 150x2510 PA SIA gr. 180	2510	150	180
182085	Brusni papir 150x2510 PA SIA gr. 240	2510	150	240
148115	Brusni papir 150x2510 PA SIA gr. 320	2510	150	320

- za robno brusilko



### Držalo za brusni papir



Šifra	Naziv	Premer (ø) mm
088492	487-014 Držalo za brusni papir 115 mm	115
088494	488-014 Držalo za brusni papir 125 mm	125

- za samolepilne brusne papirje
- hitra podložna ploščica za brusni papir za kotne brusilke
- vreteno: M14

### Držalo za brusni papir



Šifra	Naziv	Premer (ø) mm
088491	487-000 Držalo za brusni papir 115x8 mm	115
088493	488-000 Držalo za brusni papir 125x8 mm	125

- za samolepilne brusne papirje
- hitra podložna ploščica za brusni papir za vrtalnike/vijačnike in kotne brusilke
- luknja: ø 8 mm
- vreteno: M14

### Brusni krožnik



Šifra	Naziv
088715	4791-00 Brusni krožnik fi 100 mm KWB

- za brušenja lesa, kovin, PVC, mavca
- čelno ali stransko brušenje
- uporaba z vrtalniki/vijačniki
- groba
- premer: ø 100 mm
- vpetje: ø 8 mm



### Podložni krožnik ST 538



Šifra	Naziv	Premer (ø) mm	Navoj/steblo	Vrtljaji 1/min
148078	Krožnik podložni za fiber 115	115	M 14	13300
148079	Krožnik podložni za fiber 180	180	M 14	12200

- za uporabo na kotnih brusilkah
- z napejalno matico za brusilne fiber diske in papirne brusilne plošče



### Brusi in pribor - 105 delni set



Šifra	Naziv
088731	5109-00 Biax brusi in pribor 105 del

- miniaturni set brusov, brusnih trakov in pribora
- za miniaturne brusilnike
- vpetje:  $\varnothing$  3,125 mm

### Ročni brusilnik



Šifra	Naziv	Dolžina mm	Širina mm
088921	4842-00 Brusilnik ročni 93x230 mm	230	93

- za ročno brušenje
- enostavno vpetje vseh vrst brusnih papirjev
- ročaj za lažje delo
- priložena brusna papirja z zrnostjo 120 in 180

### Držalo brusnega papirja



Šifra	Naziv	Dolžina mm	Širina mm
088490	4851-21 Držalo brusnega papirja 165x87 mm	165	87

- profesionalni
- za ročno brušenje
- močne sponke za pritrditev brusnega papirja
- podlaga: mehka guma

### Brusna gobica



Šifra	Naziv	Dolžina mm	Širina mm	Višina mm
088481	0891-11 Gobica brusna 100x70x26 mm fina	100	70	26
088482	0891-21 Gobica brusna 100x70x26 mm fina/srednja	100	70	26
088483	0891-31 Gobica brusna 100x70x26 mm srednja/groba	100	70	26

- za les in kovino
- za suho in mokro brušenje
- material: aluminijev oksid
- fleksibilna, 4 stranska

### Brusna gobica

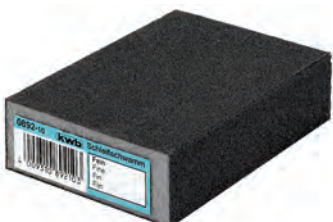

Šifra	Naziv	Dolžina mm	Širina mm	Višina mm
088484	0892-11 Gobica brusna 100x70x26 mm fina	100	70	26
088485	0892-21 Gobica brusna 100x70x26 mm fina/srednja	100	70	26
088486	0892-31 Gobica brusna 100x70x26 mm srednja/groba	100	70	26

- za pleskarje in avtoličarje
- za suho in mokro brušenje
- material: silikon karbid
- fleksibilna, 4 stranska



### Brusna gobica

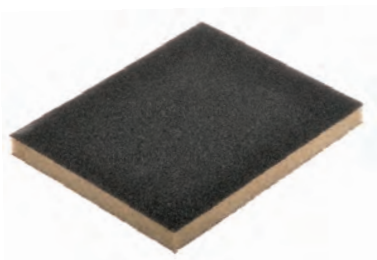

Šifra	Naziv	Dolžina mm	Širina mm	Višina mm
097210	0890-10 Gobica brusna 125x100x10 mm fina	125	100	10
097211	0890-20 Gobica brusna 125x100x10 mm srednja	125	100	10
097212	0890-30 Gobica brusna 125x100x10 mm srednja/fina	125	100	10

- za les, kovino, steklo, ...
- za suho in mokro brušenje
- 2 stranska
- v kompletu so 3 gobice

### Brusna pluta



Šifra	Naziv	Dolžina mm	Širina mm	Višina mm
088487	4848-00 Pluta brusna 40x60x100 mm	100	60	40
088488	4849-00 Pluta brusna 40x80x120 mm	120	80	40

- za ročno brušenje

### Brusni kamen



Šifra	Naziv	Dolžina mm	Širina mm	Višina mm
088068	4550-00 Kamen brusni 150x50x25 mm	150	50	25

- za ročno brušenje
- grobi/fini





# STARMAN

Starman d.o.o.  
Poslovna cona Žeje pri Komendi, Pod brezami 2, 1218 Komenda

tel.: + 386 (0)1 724 79 00  
fax: + 386 (0)1 724 79 19  
e-mail: [info@starman.si](mailto:info@starman.si)

[www.starman.si](http://www.starman.si)

junij 2016