



Pohištveni ročaji obešalniki

STARMAN

So ljudje, ki dajo lesu še lepšo obliko in podobo
in smo ljudje, ki jim pri tem pomagamo in svetujemo.

Tehnični opisi in mere v tem katalogu, tudi tiste s slikami in risbami niso zavezujoče.

Pridružujemo si pravico do oblikovnih izboljšav.

Ne prevzemamo odgovornosti za morebitne tiskarske napake ali druge napake, ki bi se lahko pojavile pri izdelavi kataloga.

Copyright: prepovedana je objava, predelava in kopiranje objavljenih vsebin, brez vednosti Starman d.o.o.

The technical descriptions and dimensions in this catalogue, also those with the photographs and drawings, are not binding.

We reserve the right to make design improvements.

We bear no liability for any misprints or other errors that might occur in the production of this catalogue.

Copyright: It is forbidden to publish, edit and copy published content without the knowledge of Starman d.o.o.

Starman d.o.o.

Poslovna cona Žeje pri Komendi









Pod brezami 2, 1218 Komenda

tel: +386 (0)1 724 79 00

e-mail: info@starman.si

www.starman.si

Kazalo

	Dvovijačni pohoštvni ročaji	4 - 18
	Enovijačni pohoštvni ročaji	19 - 21
	Brezvijačni pohoštvni ročaji (sistem smrekice)	22
	Utopni pohoštvni ročaji	23 - 28
	Aluminijasti profili	29 - 32
	Dolgi aluminijasti ročaji	33 - 36
	Obešalniki	37 - 51
	Dvižni mehanizem za čevlje	51
	Podstavek za mokro obutev	51
	Pohoštvne konzole	52 - 64
	Nosilci polic in držala polic	65 - 70
	Nosilci cevi, cevi za garderobne omare	71, 72
	Blažilci za vrata	73
	Držala za ograjo, leseni ročaj za ograjo	74, 75

POHIŠTVENI ROČAJI



LEGENDA OZNAK - PROIZVAJELEC GRIMME



LEGENDA OZNAK V TABELAH PRI POHIŠTVENIH ROČAJIH IN OBEŠALNIKIH PROIZVAJALCA GRIMME

V nazivu pomeni:

prva številka: model

druga številka: obdelava

tretja številka: razmik med luknjami v mm

Šifra	Naziv
390068	035,19,160 Poh. ročaj - inoxiran

model			
obdelava			
razmik med luknjami v mm			

OBDELAVA

- 14 inox brušen
- 16 črn
- 17 satiniran inox
- 18 inoxiran mat
- 19 inoxiran
- 20 inoxiran črno brušen
- 22 staran antik
- 23 pomedeninjen
- 27 mat nikelj
- 28 inox satiniran
- 29 krom
- 30 mat krom
- 31 mat krom lakiran
- 36 broniran
- 38 antik črn
- 39 bel
- 47 mat-eloksiran

DVOVIJAČNI POHIŠTVENI ROČAJI

CONFAIÖNIERI

POHIŠTVENI ROČAJ - ALUMINIJ



Šifra	Naziv	Dolžina mm	Razmik mm
390601	MB09112/DO Poh. ročaj 128 mm mat krom	136	128
390629	MB09112/CO Poh. ročaj 192 mm mat krom	200	192

- ročaj: aluminij
- podstavek: kovinski ulitek
- obdelava: mat krom

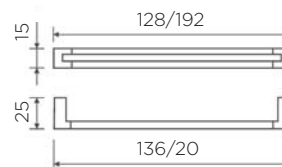

POHIŠTVENI ROČAJ - KOVINSKI ULITEK



Šifra	Naziv	Dolžina mm	Razmik mm
390602	MB09114 Poh. ročaj mat krom	150	96

- material: kovinski ulitek
- obdelava: mat krom

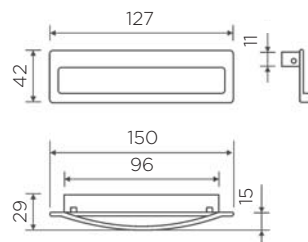

POHIŠTVENI ROČAJ - KOVINSKI ULITEK



Šifra	Naziv	Razmik mm
390606	MB09124 Poh. ročaj mat krom	28

- material: kovinski ulitek
- obdelava: mat krom

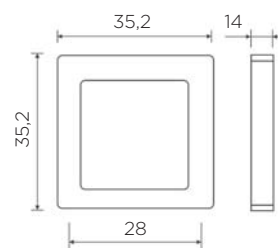

POHIŠTVENI ROČAJ - KOVINSKI ULITEK



Šifra	Naziv	Razmik mm
390612	MB09133 Poh. ročaj 16 mm mat krom	16

- material: kovinski ulitek
- obdelava: mat krom

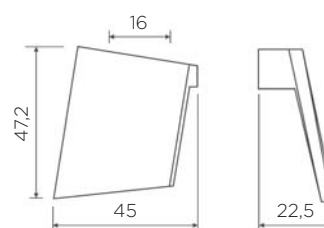

DVOVIJAČNI POHIŠTVENI ROČAJI



POHIŠTVENI ROČAJ - ALUMINIJ



Šifra	Naziv	Dolžina mm	Širina mm	Razmik mm
390068	035,19,160 Poh. ročaj - inoxiran	195	24	160
390069	035,31,160 Poh. ročaj - mat krom lakiran	195	24	160

- višina: 27 mm
- obdelava: glej tabelo

POHIŠTVENI ROČAJ - ALUMINIJ



Šifra	Naziv	Dolžina mm	Širina mm	Razmik mm
390070	036,19,192 Poh. ročaj - inoxiran	228	24	192
390071	036,30,192 Poh. ročaj - mat krom	228	24	192

- višina: 28 mm
- obdelava: glej tabelo

POHIŠTVENI ROČAJ - ALUMINIJ



Šifra	Naziv	Dolžina mm	Širina mm	Razmik mm
390256	211,28,160 Poh. ročaj - inox satiniran	172	16	160
390257	211,28,192 Poh. ročaj - inox satiniran	204	16	192
390258	211,28,256 Poh. ročaj - inox satiniran	268	16	256
390259	211,28,320 Poh. ročaj - inox satiniran	332	16	320
390260	211,28,448 Poh. ročaj - inox- satiniran	460	16	448
390261	211,28,768 Poh. ročaj - inox satiniran	780	16	768

- višina: 36 mm
- obdelava ročaja: inox satiniran
- alu montažni podstavek: 15 x 20 mm

POHIŠTVENI ROČAJ - ALUMINIJ



Šifra	Naziv	Dolžina mm	Širina mm	Razmik mm
390034	018,19,160 Poh. ročaj - inoxiran	168	20	160

- višina: 26 mm
- obdelava: inoxiran

POHIŠTVENI ROČAJ - ALUMINIJ



Šifra	Naziv	Dolžina mm	Širina mm	Razmik mm
390020	015,31,128 Poh. ročaj - mat krom lakiran	155	8	128

- višina: 26 mm
- obdelava: mat krom lakiran

DVOVIJAČNI POHIŠTVENI ROČAJI



POHIŠTVENI ROČAJ - ALUMINIJ



Šifra	Naziv	Dolžina mm	Širina mm	Razmik mm
390202	202,31,160 Poh. ročaj - mat krom lakiran	170	20	160
390203	202,31,192 Poh. ročaj - mat krom lakiran	202	20	192
390204	202,31,480 Poh. ročaj - mat krom lakiran	490	20	480

- višina: 33 mm
- obdelava: mat krom lakiran

POHIŠTVENI ROČAJ - ALUMINIJ



Šifra	Naziv	Dolžina mm	Širina mm	Razmik mm
390209	204,28,192 Poh. ročaj - inox satiniran	210	22	192
390210	204,28,288 Poh. ročaj - inox satiniran	300	22	288

- višina: 32 mm
- obdelava: inox satiniran

POHIŠTVENI ROČAJ - ALUMINIJ



Šifra	Naziv	Dolžina mm	Širina mm	Razmik mm
390216	207,47,064 Poh. ročaj - mat eloksiran	82	12	64
390217	207,47,096 Poh. ročaj - mat eloksiran	114	12	96
390218	207,47,128 Poh. ročaj - mat eloksiran	146	12	128
390219	207,47,160 Poh. ročaj - mat eloksiran	178	12	160
390220	207,47,192 Poh. ročaj - mat eloksiran	210	12	192
390221	207,47,320 Poh. ročaj - mat eloksiran	338	12	320
390222	207,47,480 Poh. ročaj - mat eloksiran	498	12	480
390223	207,47,768 Poh. ročaj - mat eloksiran	786	12	768 *
390224	207,47,818 Poh. ročaj - mat eloksiran	818	12	800 *

- višina: 34 mm
- obdelava: mat eloksiran
- z montažnim podstavkom

* ročaj s srednjim podstavkom

POHIŠTVENI ROČAJ - ALUMINIJ



Šifra	Naziv	Dolžina mm	Širina mm	Razmik mm
390225	208,47,064 Poh. ročaj - mat eloksiran	90	8	64
390226	208,47,150 Poh. ročaj - mat eloksiran	190	8	150
390227	208,47,200 Poh. ročaj - mat eloksiran	240	8	200
390228	208,47,250 Poh. ročaj - mat eloksiran	290	8	250
390229	208,47,300 Poh. ročaj - mat eloksiran	340	8	300
390230	208,47,350 Poh. ročaj - mat eloksiran	390	8	350

- višina: 34 mm
- obdelava: mat eloksiran

DVOVIJAČNI POHIŠTVENI ROČAJI



POHIŠTVENI ROČAJ - ALUMINIJ



Šifra	Naziv	Dolžina mm	Širina mm	Razmik mm
390200	201,19,192 Poh. ročaj - inoxiran	232	14	192

- višina: 35 mm
- obdelava: inoxiran

POHIŠTVENI ROČAJ - ALUMINIJ



Šifra	Naziv	Dolžina mm	Širina mm	Razmik mm
390266	213,47,128 Poh. ročaj - mat eloksiran	146	20	128

- višina: 30 mm
- obdelava: mat eloksiran

POHIŠTVENI ROČAJ - ALUMINIJ



Šifra	Naziv	Dolžina mm	Širina mm	Razmik mm
390000	001,19,128 Poh. ročaj - inoxiran	135	19	128

- višina: 28 mm
- obdelava: inoxiran

POHIŠTVENI ROČAJ - ALUMINIJ



Šifra	Naziv	Dolžina mm	Širina mm	Razmik mm
390051	030,19,160 Poh. ročaj - inoxiran	168	23	160
390053	030,31,160 Poh. ročaj - mat krom lakiran	168	23	160

- višina: 28 mm
- obdelava: glej tabelo

POHIŠTVENI ROČAJ - ALUMINIJ



Šifra	Naziv	Dolžina mm	Širina mm	Razmik mm
390262	212,47,128 Poh. ročaj - mat eloksiran	136	20	128
390263	212,47,160 Poh. ročaj - mat eloksiran	168	20	160
390264	212,47,192 Poh. ročaj - mat eloksiran	200	20	192
390265	212,47,320 Poh. ročaj - mat eloksiran	328	20	320

- višina: 35 mm
- obdelava: mat eloksiran

DVOVIJAČNI POHIŠTVENI ROČAJI



POHIŠTVENI ROČAJ - ALUMINIJ



Šifra	Naziv	Dolžina mm	Širina mm	Razmik mm
390075	038,19,128 Poh. ročaj - inoxiran	160	22	128
390076	038,30,128 Poh. ročaj - mat krom	160	22	128
390077	038,19,160 Poh. ročaj - inoxiran	192	22	160
390078	038,30,160 Poh. ročaj - mat krom	192	22	160

- višina: 28 mm
- obdelava: glej tabelo

POHIŠTVENI ROČAJ - ALUMINIJ



Šifra	Naziv	Dolžina mm	Širina mm	Razmik mm
390017	012,19,128 Poh. ročaj - inoxiran	152	20	128

- višina: 25 mm
- obdelava: inoxiran

POHIŠTVENI ROČAJ - ALUMINIJ



Šifra	Naziv	Dolžina mm	Širina mm	Razmik mm
390002	003,28,128 Poh. ročaj - inox satiniran	160	14	128
390003	003,27,128 Poh. ročaj - mat nikelj	160	14	128

- višina: 24 mm
- obdelava: glej tabelo

POHIŠTVENI ROČAJ - ALUMINIJ



Šifra	Naziv	Dolžina mm	Širina mm	Razmik mm
390008	007,28,096 Poh. ročaj - inox satiniran	108	15	96
390009	007,28,128 Poh. ročaj - inox satiniran	145	15	128

- višina: 30 mm
- obdelava: inox satiniran

POHIŠTVENI ROČAJ - ALUMINIJ



Šifra	Naziv	Dolžina mm	Širina mm	Razmik mm
390031	017,19,160 Poh. ročaj - inoxiran	180	19	160
390033	017,30,160 Poh. ročaj - mat krom	180	19	160

- višina: 26 mm
- obdelava: glej tabelo

DVOVIJAČNI POHIŠTVENI ROČAJI



POHIŠTVENI ROČAJ - ALUMINIJ



Šifra	Naziv	Dolžina mm	Širina mm	Razmik mm
390079	039,19,160 Poh. ročaj - inoxiran	202	28	160

- višina: 27 mm
- obdelava: inoxiran

POHIŠTVENI ROČAJ - ALUMINIJ



Šifra	Naziv	Dolžina mm	Širina mm	Razmik mm
390021	016,19,128 Poh. ročaj - krom inoxiran	192	27	128

- višina: 31 mm
- obdelava: krom inoxiran

POHIŠTVENI ROČAJ - ALUMINIJ



Šifra	Naziv	Dolžina mm	Širina mm	Razmik mm
390038	020,19,160 Poh. ročaj - inoxiran	202	29	160
390039	020,31,160 Poh. ročaj - mat krom lakiran	202	29	160

- višina: 26 mm
- obdelava: glej tabelo

POHIŠTVENI ROČAJ - ALUMINIJ



Šifra	Naziv	Dolžina mm	Širina mm	Razmik mm
390014	009,30,128 Poh. ročaj - mat krom	159	17	128

- višina: 27 mm
- obdelava: mat krom

POHIŠTVENI ROČAJ - ALUMINIJ



Šifra	Naziv	Dolžina mm	Premer (ø) mm	Razmik mm
390235	209,47,096 Poh. ročaj - mat eloksiran	156	12	96
390236	209,47,128 Poh. ročaj - mat eloksiran	188	12	128
390237	209,47,160 Poh. ročaj - mat eloksiran	220	12	160
390238	209,47,192 Poh. ročaj - mat eloksiran	252	12	192
390239	209,47,224 Poh. ročaj - mat eloksiran	284	12	224
390240	209,47,320 Poh. ročaj - mat eloksiran	380	12	320
390241	209,47,480 Poh. ročaj - mat eloksiran	540	12	480
390242	209,47,640 Poh. ročaj - mat eloksiran	700	12	640

- višina: 32 mm
- obdelava: mat eloksiran
- z montažnim podstavkom

DVOVIJAČNI POHIŠTVENI ROČAJI



POHIŠTVENI ROČAJ - ALUMINIJ



Šifra	Naziv	Dolžina mm	Širina mm	Razmik mm
390333	235,47,160 Poh. ročaj - mat eloksiran	180	11,6	160
390334	235,47,192 Poh. ročaj - mat eloksiran	212	11,6	192
390335	235,47,224 Poh. ročaj - mat eloksiran	244	11,6	224
390336	235,47,288 Poh. ročaj - mat eloksiran	308	11,6	288
390337	235,47,352 Poh. ročaj - mat eloksiran	372	11,6	352
390338	235,47,480 Poh. ročaj - mat eloksiran	512	11,6	480
390339	235,47,608 Poh. ročaj - mat eloksiran	640	11,6	608
390340	235,47,736 Poh. ročaj - mat eloksiran	768	11,6	736

- višina: 28 mm
- obdelava: mat eloksiran

POHIŠTVENI ROČAJ - ALUMINIJ



Šifra	Naziv	Dolžina mm	Širina mm	Razmik mm
390329	234,47,160 Poh. ročaj - mat-eloksiran	189	20	160
390330	234,47,224 Poh. ročaj - mat eloksiran	264	20	224
390331	234,47,288 Poh. ročaj - mat eloksiran	341	20	288

- višina: 32 mm
- obdelava: mat eloksiran



POHIŠTVENI ROČAJ - ZAMAK



Šifra	Naziv	Dolžina mm	Širina mm	Razmik mm
390362	243,19,128 Poh. ročaj - inoxiran	163	24	128
390363	243,30,128 Poh. ročaj - mat krom	163	24	128
390364	243,19,192 Poh. ročaj - inoxiran	227	24	192
390365	243,30,192 Poh. ročaj - mat krom	227	24	192

- višina: 25 mm
- obdelava: glej tabelo

POHIŠTVENI ROČAJ - ZAMAK



Šifra	Naziv	Dolžina mm	Širina mm	Razmik mm
390532	352,18,128 Poh. ročaj inoxiran mat	140	10	128
390533	352,18,160 Poh. ročaj inoxiran mat	172	10	160
390534	352,18,256 Poh. ročaj inoxiran mat	268	12	256
390535	352,18,320 Poh. ročaj inoxiran mat	331	12	320

- obdelava: inoxiran mat

DVOVIJAČNI POHIŠTVENI ROČAJI



POHIŠTVENI ROČAJ - ZAMAK



Šifra	Naziv	Dolžina mm	Širina mm	Razmik mm
390527	349,20,160 Poh. ročaj inoxiran črno bruš.	175	19	160

- višina: 30 mm
- obdelava: inoxiran, črno brušen

POHIŠTVENI ROČAJ - ZAMAK



Šifra	Naziv	Dolžina mm	Širina mm	Razmik mm
390530	351,20,160 Poh. ročaj inoxiran črno bruš.	210	18	160
390531	351,20,320 Poh. ročaj inoxiran črno bruš.	375	19	320

- višina: 26 mm
- obdelava: inoxiran, črno brušen

POHIŠTVENI ROČAJ - ZAMAK



Šifra	Naziv	Dolžina mm	Širina mm	Razmik mm
390525	348,18,192 Poh. ročaj inoxiran mat	210	19	192
390526	348,18,320 Poh. ročaj inoxiran mat	338	26	320

- višina: 25 mm
- obdelava: inoxiran mat

POHIŠTVENI ROČAJ - ZAMAK



Šifra	Naziv	Dolžina mm	Širina mm	Razmik mm
390528	350,20,128 Poh. ročaj inoxiran črno bruš.	166	13	128
390529	350,20,160 Poh. ročaj inoxiran črno bruš.	200	13	160

- višina: 31 mm
- obdelava: inoxiran, črno brušen

POHIŠTVENI ROČAJ - ZAMAK



Šifra	Naziv	Dolžina mm	Razmik mm
390382	347,38,128 Poh. ročaj - antik črn	158	128

- višina: 34 mm
- obdelava: antik črn
- videz: starinski

DVOVIJAČNI POHIŠTVENI ROČAJI



POHIŠTVENI ROČAJ - ZAMAK



Šifra	Naziv	Dolžina mm	Širina mm	Razmik mm
390546	355,22,128 Poh. ročaj staran antik	152	24	128

- višina: 25 mm
- obdelava: staran antik
- videz: starinski

POHIŠTVENI ROČAJ - ZAMAK



Šifra	Naziv	Dolžina mm	Širina mm	Razmik mm
390547	356,22,128 Poh. ročaj staran antik mat	152	19	128

- višina: 26 mm
- obdelava: staran antik mat
- videz: starinski

POHIŠTVENI ROČAJ - ZAMAK



Šifra	Naziv	Dolžina mm	Razmik mm
390374	346,36,078 Poh. ročaj - broniran	89	78

- višina: 25 mm
- obdelava: broniran
- videz: starinski

PODLOŽNA PLOŠČICA - JEKLO



Šifra	Naziv	Dolžina mm	Širina mm	Razmik mm
390373	346,36,078 Ploščica podložna bronirana	142	25	78

- debelina: 2 mm
- obdelava: bronirana



primer sestave: ročaj + podložna ploščica

POHIŠTVENI ROČAJ - STEKLO IN ZAMAK



Šifra	Naziv	Dolžina mm	Širina mm	Razmik mm
390357	241,29,160 Poh. ročaj - krom	174	35	160
390358	241,29,224 Poh. ročaj - krom	238	35	224
390359	241,29,320 Poh. ročaj - krom	334	35	320

- višina: 31 mm
- ročaj: steklo
- podstavek: zamak, obdelava: krom

DVOVIJAČNI POHIŠTVENI ROČAJI



POHIŠTVENI ROČAJ - INOX IN ZAMAK



Šifra	Naziv	Dolžina mm	Premer (ø) mm	Razmik mm
390120	103,17,096 Poh. ročaj - satiniran inox	118	12	96
390121	103,17,128 Poh. ročaj - satiniran inox	150	12	128
390122	103,17,160 Poh. ročaj - satiniran inox	182	12	160
390123	103,17,192 Poh. ročaj - satiniran inox	214	12	192
390124	103,17,224 Poh. ročaj - satiniran inox	246	12	224
390125	103,17,288 Poh. ročaj - satiniran inox	310	12	288
390126	103,17,320 Poh. ročaj - satiniran inox	342	12	320
390127	103,17,352 Poh. ročaj - satiniran inox	374	12	352
390128	103,17,448 Poh. ročaj - satiniran inox	470	12	448
390196	103,17,480 Poh. ročaj - satiniran inox	502	12	480

- višina: 34 mm
- ročaj: inox, obdelava: satiniran inox
- podstavek: zamak, obdelava: inoksidiran

POHIŠTVENI ROČAJ - INOX



Šifra	Naziv	Dolžina mm	Širina mm	Razmik mm
390169	110,17,160 Poh. ročaj - satiniran inox	175	15	160
390170	110,17,192 Poh. ročaj - satiniran inox	207	15	192
390171	110,17,224 Poh. ročaj - satiniran inox	239	15	224
390172	110,17,320 Poh. ročaj - satiniran inox	335	15	320
390173	110,17,448 Poh. ročaj - satiniran inox	463	15	448
390174	110,17,608 Poh. ročaj - satiniran inox	623	15	608
390175	110,17,640 Poh. ročaj - satiniran inox	655	15	640

- višina: 38 mm
- obdelava: satiniran inox

POHIŠTVENI ROČAJ - INOX



Šifra	Naziv	Dolžina mm	Premer (ø) mm	Razmik mm
390100	101,17,096 Poh. ročaj - satiniran inox	109	12,7	96
390101	101,17,128 Poh. ročaj - satiniran inox	140	12,7	128
390102	101,17,160 Poh. ročaj - satiniran inox	173	12,7	160
390103	101,17,192 Poh. ročaj - satiniran inox	205	12,7	192
390104	101,17,288 Poh. ročaj - satiniran inox	300	12,7	288
390105	101,17,320 Poh. ročaj - satiniran inox	333	12,7	320
390106	101,17,384 Poh. ročaj - satiniran inox	397	12,7	384
390107	101,17,480 Poh. ročaj - satiniran inox	493	12,7	480
390108	101,17,736 Poh. ročaj - satiniran inox	749	12,7	736

- višina: 35 mm
- obdelava: satiniran inox

DVOVIJAČNI POHIŠTVENI ROČAJI



POHIŠTVENI ROČAJ - INOX



Šifra	Naziv	Dolžina mm	Premer (ø) mm	Razmik mm
390140	105,17,064 Poh. ročaj - satiniran inox	74	10	64
390141	105,17,096 Poh. ročaj - satiniran inox	106	10	96
390142	105,17,128 Poh. ročaj - satiniran inox	138	10	128
390143	105,17,160 Poh. ročaj - satiniran inox	170	10	160
390144	105,17,192 Poh. ročaj - satiniran inox	202	10	192
390145	105,17,224 Poh. ročaj - satiniran inox	234	10	224
390146	105,17,288 Poh. ročaj - satiniran inox	298	10	288
390147	105,17,320 Poh. ročaj - satiniran inox	330	10	320
390148	105,17,416 Poh. ročaj - satiniran inox	426	10	416
390149	105,17,448 Poh. ročaj - satiniran inox	458	10	448
390150	105,17,512 Poh. ročaj - satiniran inox	522	10	512
390151	105,17,544 Poh. ročaj - satiniran inox	554	10	544
390152	105,17,640 Poh. ročaj - satiniran inox	650	10	640
390153	105,17,736 Poh. ročaj - satiniran inox	746	10	736
390154	105,17,832 Poh. ročaj - satiniran inox	842	10	832

- višina: 35 mm
- obdelava: satiniran inox

POHIŠTVENI ROČAJ - INOX



Šifra	Naziv	Dolžina mm	Premer (ø) mm	Razmik mm
390155	106,17,096 Poh. ročaj - satiniran inox	115	10	96
390156	106,17,128 Poh. ročaj - satiniran inox	152	10	128
390157	106,17,160 Poh. ročaj - satiniran inox	187	10	160
390158	106,17,192 Poh. ročaj - satiniran inox	224	10	192
390159	106,17,224 Poh. ročaj - satiniran inox	263	10	224
390160	106,17,288 Poh. ročaj - satiniran inox	345	10	288
390161	106,17,320 Poh. ročaj - satiniran inox	379	10	320

- višina: 32 mm
- obdelava: satiniran inox

POHIŠTVENI ROČAJ - INOX



Šifra	Naziv	Dolžina mm	Premer (ø) mm	Razmik mm
390129	104,17,096 Poh. ročaj - satiniran inox	176	14	96
390130	104,17,128 Poh. ročaj - satiniran inox	208	14	128
390131	104,17,160 Poh. ročaj - satiniran inox	240	14	160
390132	104,17,192 Poh. ročaj - satiniran inox	272	14	192
390133	104,17,224 Poh. ročaj - satiniran inox	304	14	224
390134	104,17,288 Poh. ročaj - satiniran inox	368	14	288
390135	104,17,320 Poh. ročaj - satiniran inox	400	14	320
390136	104,17,384 Poh. ročaj - satiniran inox	464	14	384
390137	104,17,480 Poh. ročaj - satiniran inox	560	14	480
390138	104,17,576 Poh. ročaj - satiniran inox	656	14	576
390139	104,17,640 Poh. ročaj - satiniran inox	720	14	640

- višina: 35 mm
- obdelava: satiniran inox

DVOVIJAČNI POHIŠTVENI ROČAJI



POHIŠTVENI ROČAJ - INOX



Šifra	Naziv	Dolžina mm	Širina mm	Razmik mm
390395	246,17,128 Poh. ročaj inox brušen	200	10	128
390396	246,17,224 Poh. ročaj inox brušen	296	10	224

- višina: 30 mm
- obdelava: inox brušen
- votel

POHIŠTVENI ROČAJ - INOX



Šifra	Naziv	Dolžina mm	Premer (ø) mm	Razmik mm
390536	353,14,096 Poh. ročaj inox brušen	176	12	96
390537	353,14,128 Poh. ročaj inox brušen	208	12	128
390538	353,14,160 Poh. ročaj inox brušen	240	12	160
390539	353,14,192 Poh. ročaj inox brušen	272	12	192
390540	353,14,224 Poh. ročaj inox brušen	304	12	224
390541	353,14,288 Poh. ročaj inox brušen	368	12	288
390542	353,14,320 Poh. ročaj inox brušen	400	12	320
390543	353,14,480 Poh. ročaj inox brušen	560	12	480
390544	353,14,640 Poh. ročaj inox brušen	720	12	640

- višina: 33 mm
- obdelava: inox brušen
- votel

DVOVIJAČNI POHIŠTVENI ROČAJI



POHIŠTVENI ROČAJ - JEKLO IN ZAMAK



Šifra	Naziv	Dolžina mm	Širina mm	Razmik mm
390295	237,30,320 Poh. ročaj - mat krom	332	12	320
390296	237,30,800 Poh. ročaj - mat krom	812	12	800

- višina: 30 mm
- ročaj: jeklo, obdelava: mat krom
- podstavek: zamak, obdelava: mat-krom

POHIŠTVENI ROČAJ - JEKLO IN ZAMAK



Šifra	Naziv	Dolžina mm	Premer (ø) mm	Razmik mm
390290	227,32,192 Poh. ročaj - mat krom lakiran	216	16	192

- višina: 40 mm
- ročaj: jeklo, obdelava: mat krom lakiran
- podstavek: zamak, obdelava: mat krom lakiran

POHIŠTVENI ROČAJ - JEKLO



Šifra	Naziv	Dolžina mm	Premer (ø) mm	Razmik mm
125259	Ročaj lok 96 mm - mat krom	115	10	96
125301	Ročaj lok 128 mm - mat krom	151	10	128
125393	Ročaj lok 160 mm - mat krom	190	10	160
125256	Ročaj lok 192 mm - mat krom	225	10	192
125252	Ročaj lok 224 mm - mat krom	264	10	224

- višina: 30 mm (razmik 96 in 128 mm)
- višina: 32 mm (razmik 160, 192 in 224 mm)
- obdelava: mat krom

POHIŠTVENI ROČAJ - JEKLO



Šifra	Naziv	Dolžina mm	Premer (ø) mm	Razmik mm
390282	219,30,128 Poh. ročaj - mat krom	188	10	128

- višina: 30 mm
- obdelava: mat krom

DVOVIJAČNI POHIŠTVENI ROČAJI



POHIŠTVENI ROČAJ - PVC



Šifra	Naziv	Razmik mm
126207	Ročaj pohištveni 306 črn	160
126209	Ročaj pohištveni 306 rdeč	160
126208	Ročaj pohištveni 306 siv	160
126206	Ročaj pohištveni 306 bel	160

- prozorno ohišje
- znotraj različne barve (glej tabelo)

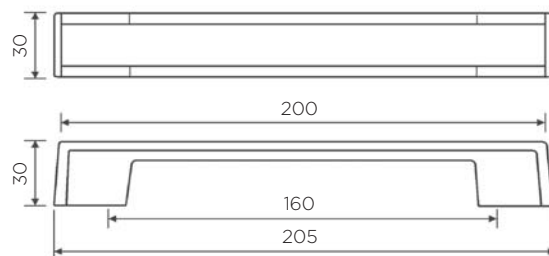

POHIŠTVENI ROČAJ - PVC



Šifra	Naziv	Razmik mm
126200	Ročaj pohištveni 037B bel/RAL9006	160
126198	Ročaj pohištveni 037B črn/RAL9006	160
126199	Ročaj pohištveni 037B satinato/RAL9006	160

- barva: glej tabelo

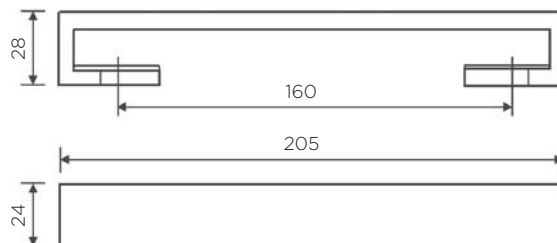

POHIŠTVENI ROČAJ - PVC



Šifra	Naziv	Dolžina mm	Višina mm	Razmik mm
126210	Ročaj pohištveni 300C RAL9006	182	26	128
126211	Ročaj pohištveni 300E RAL9006	250	29	192

- barva: RAL 9006

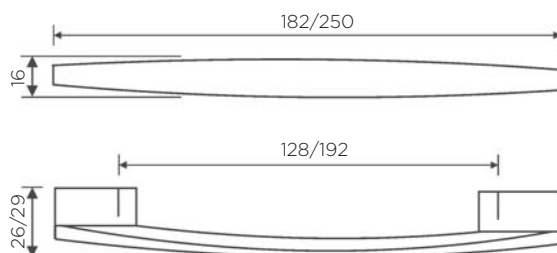

DVOVIJAČNI POHIŠTVENI ROČAJI



POHIŠTVENI ROČAJ - ABS



Šifra	Naziv	Razmik mm
126223	Ročaj pohištveni 337B RAL9006	160

- barva: RAL 9006

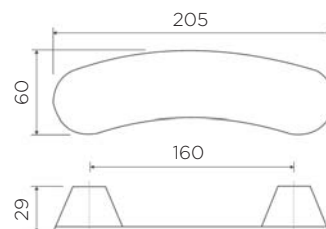

POHIŠTVENI ROČAJ - ABS



Šifra	Naziv	Razmik mm
126204	Ročaj pohištveni 430 RAL9006	64
126205	Ročaj pohištveni 430 bel	64

- barva: glej tabelo

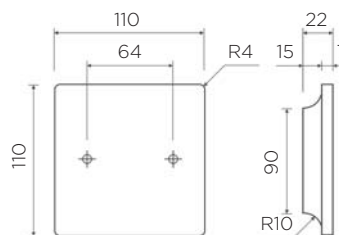

POHIŠTVENI ROČAJ - ABS



Šifra	Naziv	Razmik mm
126222	Ročaj pohištveni 311 RAL9006	64

- barva: RAL 9006

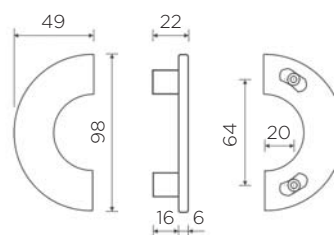

POHIŠTVENI ROČAJ - ABS



Šifra	Naziv	Razmik mm
126221	Ročaj pohištveni 310 RAL9006	64

- barva: RAL 9006

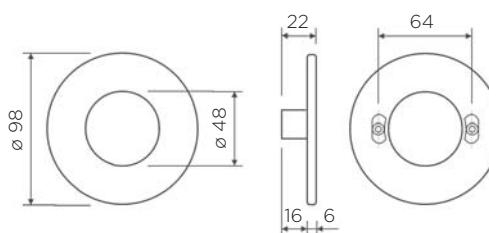

ENOVIAČNI POHIŠTVENI ROČAJI



POHIŠTVENI ROČAJ - ALUMINIJ



Šifra	Naziv	Premer (ø) mm	Višina mm
390275	217,47,G20 Poh. ročaj - mat eloksiran	20	21
390276	217,47,G25 Poh. ročaj - mat eloksiran	25	26
390277	217,47,G30 Poh. ročaj - mat eloksiran	30	35

- obdelava: mat eloksiran

POHIŠTVENI ROČAJ - ALUMINIJ



Šifra	Naziv	Premer (ø) mm	Višina mm
390272	216,47,G20 Poh. ročaj - mat eloksiran	20	25
390273	216,47,G24 Poh. ročaj - mat eloksiran	24	30

- obdelava: mat eloksiran

POHIŠTVENI ROČAJ - ALUMINIJ



Šifra	Naziv	Premer (ø) mm	Višina mm
390269	215,47,G12 Poh. ročaj - mat eloksiran	12	20
390270	215,47,G15 Poh. ročaj - mat eloksiran	15	22
390271	215,47,G18 Poh. ročaj - mat eloksiran	18	25

- obdelava: mat eloksiran

POHIŠTVENI ROČAJ - ALUMINIJ



Šifra	Naziv	Premer (ø) mm	Višina mm
390016	011,31,G20 Poh. ročaj - mat krom lakiran	20	28

- obdelava: mat krom lakiran

POHIŠTVENI ROČAJ - ALUMINIJ



Šifra	Naziv	Presek mm	Višina mm
390268	214,47,G12x12 Poh. ročaj - mat eloksiran	12 x 12	22

- obdelava: mat eloksiran

ENOVIAČNI POHIŠTVENI ROČAJI



POHIŠTVENI ROČAJ - ZAMAK



Šifra	Naziv	Mere mm	Višina mm
390545	354,22,G28x28 Poh. ročaj staran antik	28x28	27

- obdelava: staran antik

POHIŠTVENI ROČAJ - INOX



Šifra	Naziv	Premer (ø) mm	Višina mm
390180	112,17,G20 Poh. ročaj - satiniran-inox	20	25
390181	112,17,G24 Poh. ročaj - satiniran-inox	24	30

- obdelava: satiniran-inox

POHIŠTVENI ROČAJ - INOX



Šifra	Naziv	Premer (ø) mm	Višina mm
390176	111,17,G12 Poh. ročaj - satiniran inox	12	20
390177	111,17,G15 Poh. ročaj - satiniran inox	15	20
390178	111,17,G18 Poh. ročaj - satiniran inox	18	25
390179	111,17,G21 Poh. ročaj - satiniran inox	21	25

- obdelava: satiniran inox

POHIŠTVENI ROČAJ - INOX



Šifra	Naziv	Premer (ø) mm	Višina mm
390183	113,17,G20 Poh. ročaj - satiniran inox	20	22
390184	113,17,G25 Poh. ročaj - satiniran inox	25	26

- obdelava: satiniran inox

ENOVIJAČNI POHIŠTVENI ROČAJI



POHIŠTVENI ROČAJ - ABS



Šifra	Naziv
126203	Ročaj pohištveni 414Q bel/RAL9006
126201	Ročaj pohištveni 414Q črn/RAL9006
126202	Ročaj pohištveni 414Q satinato/RAL9006

- barva: glej tabelo

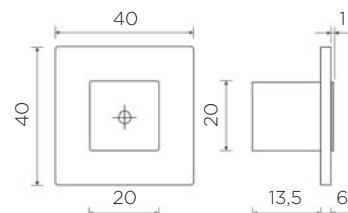

POHIŠTVENI ROČAJ - ABS



Šifra	Naziv
126218	Ročaj pohištveni 440 bel/RAL9006
126219	Ročaj pohištveni 440 temno roza/RAL9006
126220	Ročaj pohištveni 440 svetlo moder/RAL9006

- barva: glej tabelo

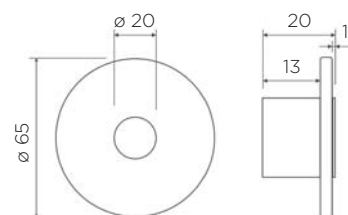

POHIŠTVENI ROČAJ - ABS



Šifra	Naziv
126216	Ročaj pohištveni 427E svetlo moder
126217	Ročaj pohištveni 427E zelen

- barva: glej tabelo

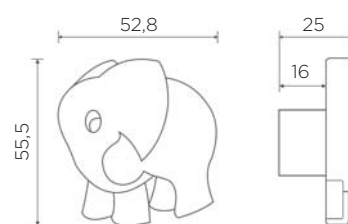

POHIŠTVENI ROČAJ - ABS



Šifra	Naziv
126212	Ročaj pohištveni 427F svetlo roza
126213	Ročaj pohištveni 427F temno roza
126214	Ročaj pohištveni 427F svetlo moder
126215	Ročaj pohištveni 427F zelen

- barva: glej tabelo

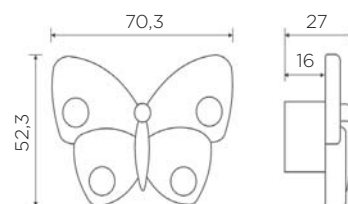

BREZVIJAČNI POHIŠTVENI ROČAJI



POHIŠTVENI ROČAJ - ALUMINIJ



Šifra	Naziv	Dolžina mm	Širina mm
390385	802 Alu poh. ročaj - inox satiniran L=146 mm	146	38
390386	802 Alu poh. ročaj - inox satiniran L=246 mm	246	38
390387	802 Alu poh. ročaj - inox satiniran L=296 mm	296	38
390388	802 Alu poh. ročaj - inox satiniran L=346 mm	346	38
390389	802 Alu poh. ročaj - inox satiniran L=396 mm	396	38
390390	802 Alu poh. ročaj - inox satiniran L=446 mm	446	38
390391	802 Alu poh. ročaj - inox satiniran L=496 mm	496	38
390392	802 Alu poh. ročaj - inox satiniran L=596 mm	596	38

- višina: 14 mm
- obdelava: inox satiniran
- brez lukenj za vijake (sistem smrekice za montažo v izrez)

UTOPNI POHIŠTVENI ROČAJI

CONFAIONIERI

UTOPNI POHIŠTVENI ROČAJ - KOV. ULITEK



Šifra	Naziv
390613	MB09134/A Utopni ročaj - mat krom

- material: kovinski ulitek
- obdelava: mat krom

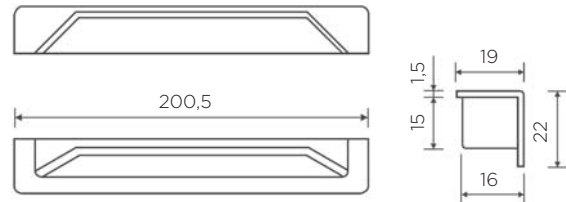

UTOPNI POHIŠTVENI ROČAJ - KOV. ULITEK



Šifra	Naziv
390600	MB09107/A Utopni ročaj - mat krom

- material: kovinski ulitek
- obdelava: mat krom

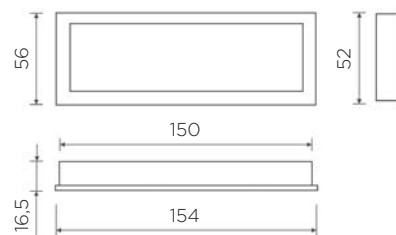

UTOPNI POHIŠTVENI ROČAJ - KOV. ULITEK



Šifra	Naziv
390609	MB09129/A Utopni ročaj - mat krom

- material: kovinski ulitek
- obdelava: mat krom

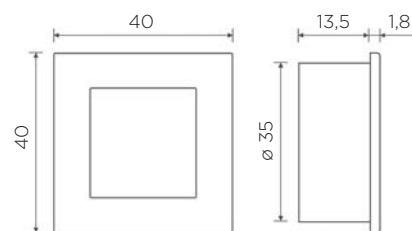

UTOPNI POHIŠTVENI ROČAJ - KOV. ULITEK



Šifra	Naziv	Razmik mm
390611	MB09132B Utopni ročaj 55x55 mm - mat krom	32
390627	MB09132A Utopni ročaj 110x110 mm - mat krom	96

- material: kovinski ulitek
- obdelava: mat krom

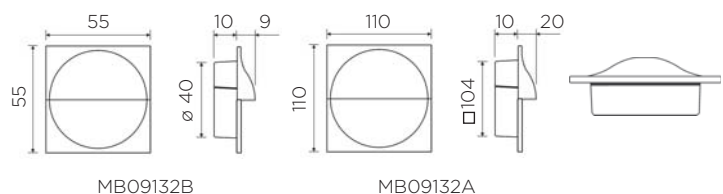

UTOPNI POHIŠTVENI ROČAJI



UTOPNI POHIŠTVENI ROČAJ - ZAMAK



Šifra	Naziv	Dolžina mm	Širina mm	Razmik mm
390507	503,28,135x40 Utopni ročaj - mat nikelj	139	45	128

- obdelava: mat nikelj

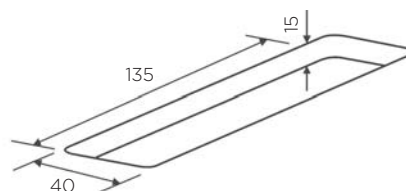

UTOPNI POHIŠTVENI ROČAJ - ZAMAK



Šifra	Naziv	Dolžina mm	Širina mm	Razmik mm
390505	502,19,200x56 Utopni ročaj - inoxiran	204	60	192
390506	502,31,200x56 Utopni ročaj - mat kr. lak.	204	60	192

- obdelava: glej tabelo

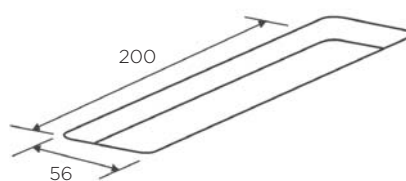

UTOPNI POHIŠTVENI ROČAJ - ZAMAK



Šifra	Naziv	Dolžina mm	Širina mm
390510	504,31,104x38 Utopni ročaj - mat krom lakiran	108	42

- obdelava: mat krom lakiran

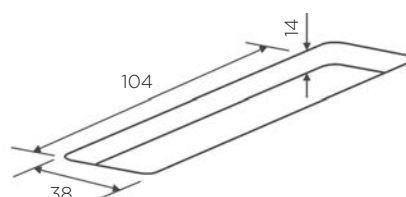

UTOPNI POHIŠTVENI ROČAJ - ZAMAK



Šifra	Naziv	Dolžina mm	Širina mm
390517	506,19,119x40 Utopni ročaj - inoxiran	119	40
390518	506,30,119x40 Utopni ročaj - mat krom	119	40

- višina: 17 mm
- obdelava: glej tabelo

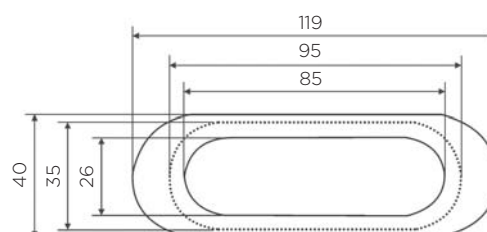

UTOPNI POHIŠTVENI ROČAJI



UTOPNI POHIŠTVENI ROČAJ - ZAMAK



Šifra	Naziv	Premer (ø) mm	Luknja (ø) mm
390500	500,29,035 Utopni ročaj - krom	40	35
390501	500,30,035 Utopni ročaj - mat krom	40	35

- višina: 12 mm
- obdelava: glej tabelo



UTOPNI POHIŠTVENI ROČAJ - INOX



Šifra	Naziv	Premer (ø) mm	Luknja (ø) mm
390504	501,19,035 Utopni ročaj - inoxiran	40	35
390503	501,19,040 Utopni ročaj - inoxiran	50	40
390502	501,19,060 Utopni ročaj - inoxiran	70	60

- višina: 16 mm
- obdelava: inoxiran



UTOPNI POHIŠTVENI ROČAJ - INOX



Šifra	Naziv	Dolžina mm	Širina mm
390509	503,17,155x45 Utopni ročaj - satiniran inox	180	60

- višina: 19 mm
- obdelava: satiniran inox

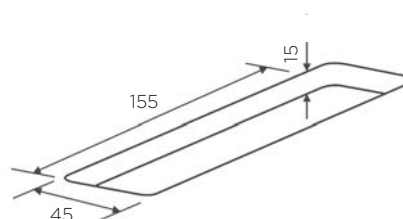

UTOPNI POHIŠTVENI ROČAJI



UTOPNI POHIŠTVENI ROČAJ - MEDENINA



Šifra	Naziv	Premer (ø) mm	Luknja (ø) mm
128173	X-Utopni ročaj za drsna vrata fi 26 mm - krom	30	26
128174	X-Utopni ročaj za drsna vrata fi 26 mm - alu	30	26
129006	X-Utopni ročaj za drsna vrata fi 35 mm - krom	43	35

- za steklena drsna vrata
- za steklo 4-8 mm
- material: medenina
- obdelava: glej tabelo

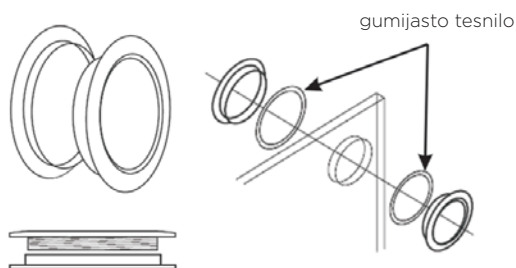

UTOPNI POHIŠTVENI ROČAJ - PVC



Šifra	Naziv	Barva
126224	Ročaj utopni O56 fi 50 mm RAL9006	RAL9006

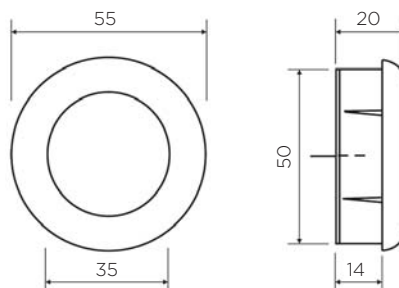

UTOPNI POHIŠTVENI ROČAJ - PVC



Šifra	Naziv	Barva
126193	Ročaj utopni O53 fi 35 mm RAL9006	RAL9006

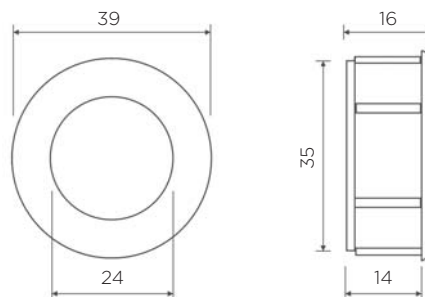

UTOPNI POHIŠTVENI ROČAJI



UTOPNI POHIŠTVENI ROČAJ - PVC



Šifra	Naziv
126226	Ročaj utopni 059 fi 50 mm RAL9006

- barva: RAL9006

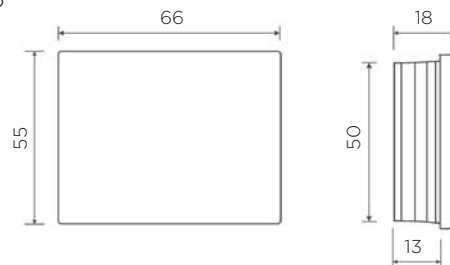

UTOPNI POHIŠTVENI ROČAJ - PVC



Šifra	Naziv
126225	Ročaj utopni 344 fi 35 mm RAL9006

- barva: RAL9006

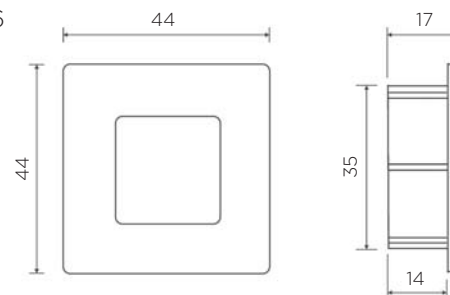

UTOPNI POHIŠTVENI ROČAJ - PVC



Šifra	Naziv
126194	Ročaj utopni 069 75x26 mm RAL9006

- barva: RAL9006

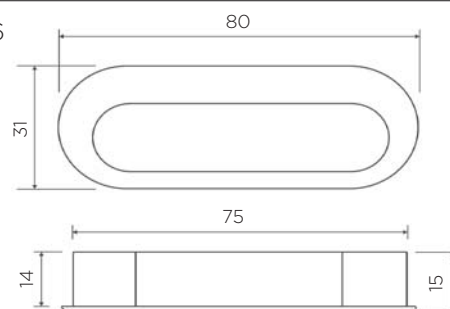

UTOPNA POHIŠTVENA ROČAJA "QUADRA"

KOBLLENZ

UTOPNA POHIŠTVENA ROČAJA "KUADRA"

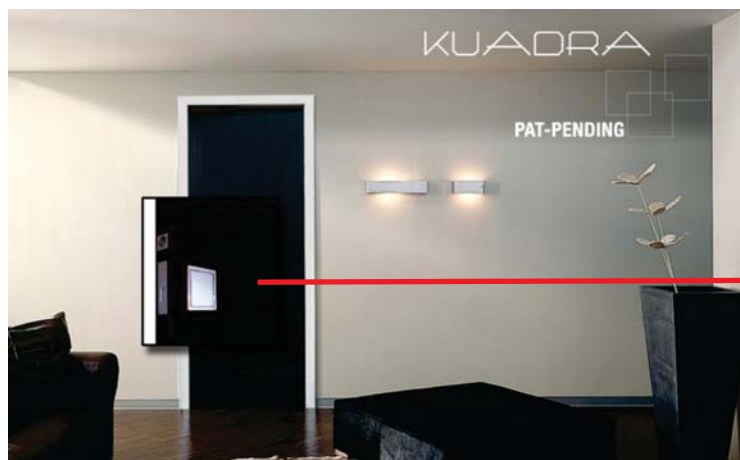

S KLJUČAVNICO



obdelava: krom-satiniran
za debelino vrat: 35 - 50 mm

- ročaj s ključavnico onemogoča odpiranje vrat s strani brez ključavnice
- ko zapremo vrata jih lahko odpremo samo s strani, kjer je nameščen ročaj s ključavnico
- za zaklepanje ne potrebujemo ključa

Šifra Naziv

092063 Kuadra ročaj krom mat s ključavnico

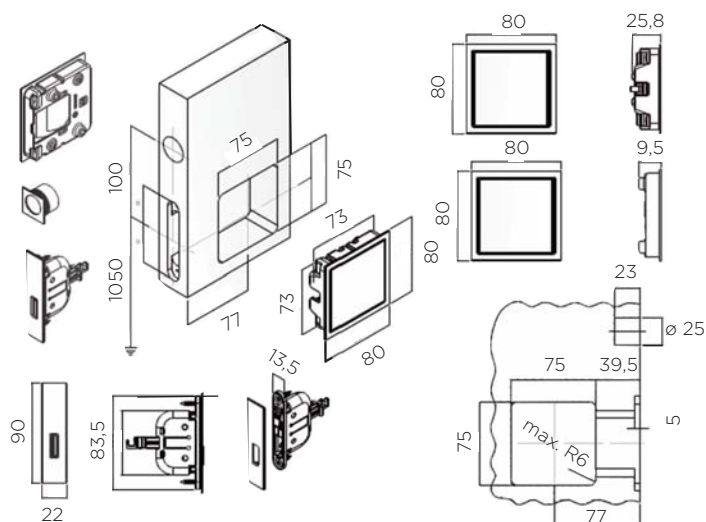

BREZ KLJUČAVNICE



obdelava: krom-satiniran
za debelino vrat: 35 - 50 mm

Šifra Naziv

092062 Kuadra ročaj krom mat Q100

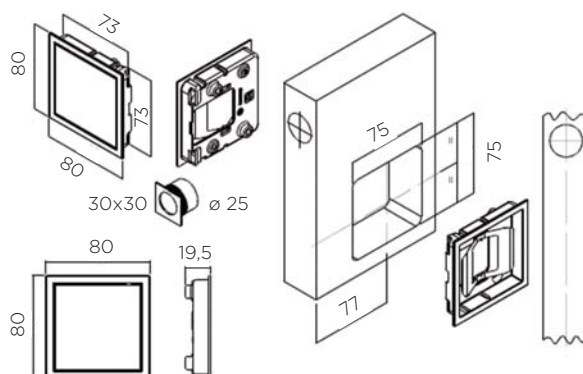



ALUMINIJASTI PROFILI "GOLA"



HORIZONTALNI ALU PROFIL "GOLA"



kapica L za zunanji profil



kapica L za notranji profil



notranji vogalnik



zunanji vogalnik

Šifra	Naziv	Dolžina mm
092220	Profil "GOLA" L horizontalni L = 4,2 m alu	4200
092260	Profil "GOLA" L horizontalni L = 4,2 m bel	4200
092224	Kapice "GOLA" L za zunanji horizontalni alu	
092267	Kapice "GOLA" L za zunanji horizontalni bele	
092232	Kapice "GOLA" L za notranji horizontalni alu	
092268	Kapice "GOLA" L za notranji horizontalni bele	
092226	Vogalnik "GOLA" zunanji 90° alu	
092266	Vogalnik "GOLA" zunanji 90° bel	
092225	Vogalnik "GOLA" notranji 90° alu	
092265	Vogalnik "GOLA" notranji 90° bel	

- za montažo pod delovno ploščo
- v primeru uporabe profila na ličnicah predalov ne potrebujemo pohištenih ročajev, saj predal lahko odpremo tako, da primemo za rob ličnice

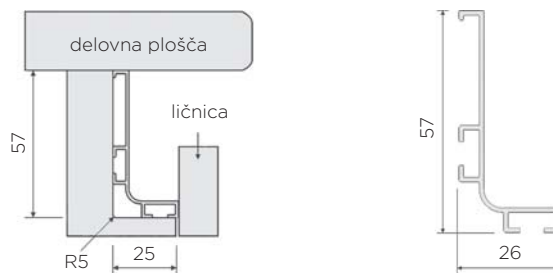

HORIZONTALNI ALU PROFIL "GOLA"



kapica C za zunanji profil



kapica C za notranji profil

Šifra	Naziv	Dolžina mm
092221	Profil "GOLA" C horizontalni L = 4,2 m alu	4200
092261	Profil "GOLA" C horizontalni L = 4,2 m bel	4200
092227	Kapice "GOLA" C za zunanji horizontalni alu	
092269	Kapice "GOLA" C za zunanji horizontalni bele	
092231	Kapice "GOLA" C za notranji horizontalni alu	
092270	Kapice "GOLA" C za notranji horizontalni bele	

- za montažo med dva predala
- v primeru uporabe profila na ličnicah predalov ne potrebujemo pohištenih ročajev, saj predal lahko odpremo tako, da primemo za rob ličnice

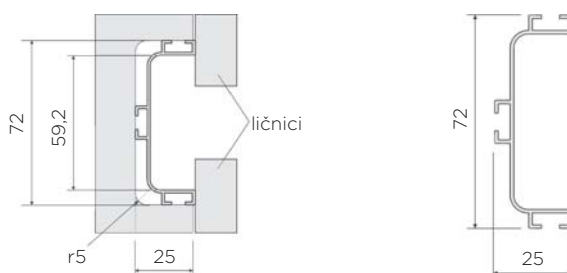

ALUMINIJASTI PROFILI "GOLA"



HORIZONTALNI ALU PROFIL "GOLA"



s tesnilom

Šifra	Naziv	Dolžina mm
092219	Profil "GOLA" zgornji horizontalni L = 4,2 m alu	4200

- za montažo na dno viseče omare
- v primeru uporabe profila za vrata viseče omare ne potrebujemo pohištenih ročajev, saj vrata lahko odpremo tako, da primemo za spodnji del vrat viseče omare

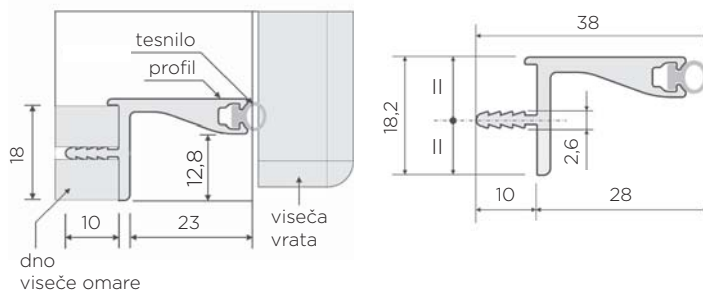

HORIZONTALNI ALU PROFIL "GOLA"



brez tesnila

Šifra	Naziv	Dolžina mm
092262	Profil "GOLA" zgornji horizontalni L = 4,2 m bel	4200

- za montažo na dno viseče omare
- v primeru uporabe profila za vrata viseče omare ne potrebujemo pohištenih ročajev, saj vrata lahko odpremo tako, da primemo za spodnji del vrat viseče omare

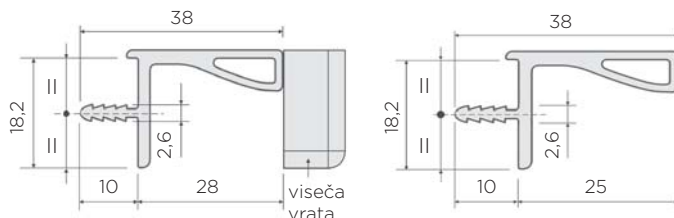

VERTIKALNI ALU PROFIL "GOLA"

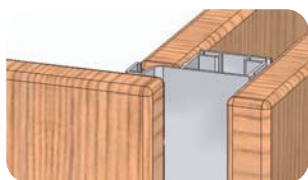
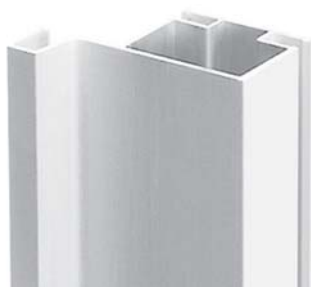

Šifra	Naziv	Dolžina mm
092223	Profil "GOLA" enojni vertikalni L = 4,7 m alu	4700
092263	Profil "GOLA" enojni vertikalni L = 4,7 m bel	4700

- za montažo med pohištena vrata
- v primeru uporabe profila za vrata viseče omare ne potrebujemo pohištenih ročajev, saj vrata lahko odpremo tako, da primemo za spodnji del vrat viseče omare

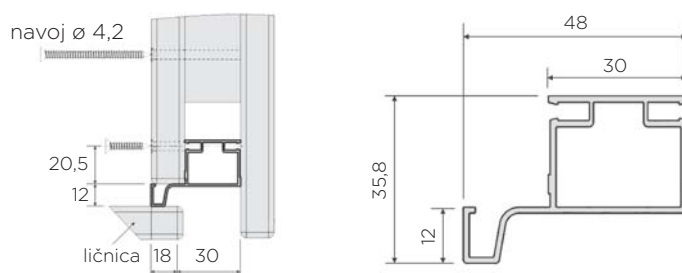

VERTIKALNI ALUMINIJASTI PROFIL "GOLA", PRIBOR



VERTIKALNI ALU PROFIL "GOLA"



Šifra	Naziv	Dolžina mm
092222	Profil "GOLA" dvojni vertikalni L = 4,7 m alu	4700
092264	Profil "GOLA" dvojni vertikalni L = 4,7 m bel	4700

- za montažo med pohištvena vrata
- v primeru uporabe profila na pohištvenih vratih ne potrebujemo pohištvenih ročajev, saj vrata lahko odpremo tako, da primemo zastranjski rob vrat
- na en aluminijasti profil lahko zapremo dve pohištveni vrat

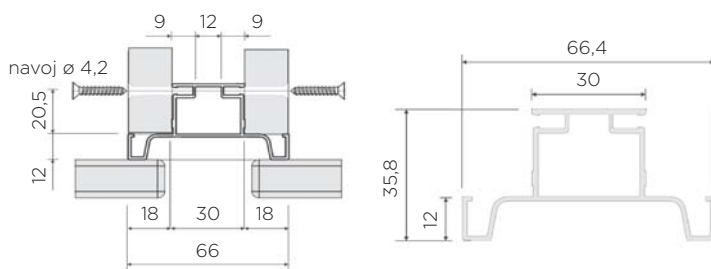

VOGALNIKI ZA PRITRDITEV PROFILA



Šifra	Naziv
092228	Vogalniki "GOLA" za pritrnitev alu profila

- set vsebuje:**
- 2 pritrdilni plošči
 - 4 pocinkane vijake M4x4
 - 4 vijake za iverne plošče $\varnothing 3,5 \times 12$
 - 4 podložke $\varnothing 12 \times 1$

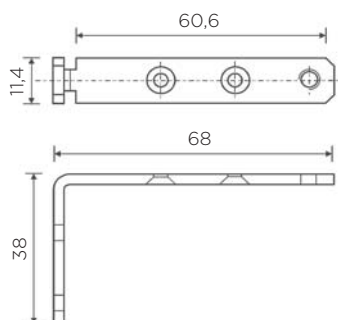

DOLGI ALUMINIJASTI ROČAJI



ALUMINIJASTI ROČAJ ZA 19 MM

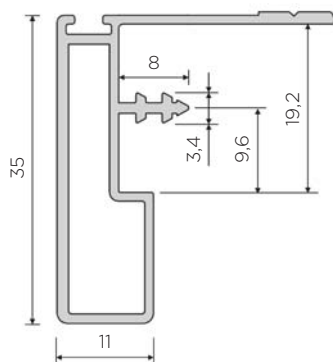

Šifra	Naziv	Dolžina mm
092245	931 Alu vratni ročaj za 19 mm L = 2780mm	2780
092247	Krtačka tesnilna za alu ročaj 931,932	



krtačka

ALUMINIJASTI SLEPI ROČAJ ZA 19 MM

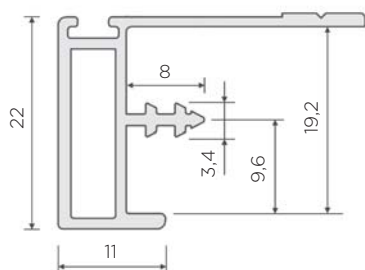

Šifra	Naziv	Dolžina mm
092246	932 Alu slepi ročaj za 19 mm L = 2780mm	2780
092247	Krtačka tesnilna za alu ročaj 931,932	



krtačka

ALUMINIJASTI ROČAJ ZA 25 MM

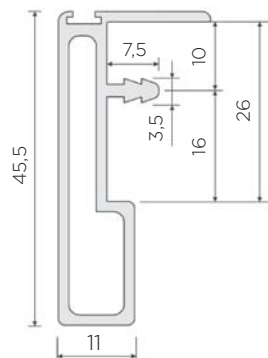

Šifra	Naziv	Dolžina mm
092173	172 Alu vratni ročaj za 25 mm L = 3000 mm	3000
092169	O66 Krtačka tesnilna za ročaj 25 mm	



krtačka

ALUMINIJASTI SLEPI ROČAJ ZA 25 MM

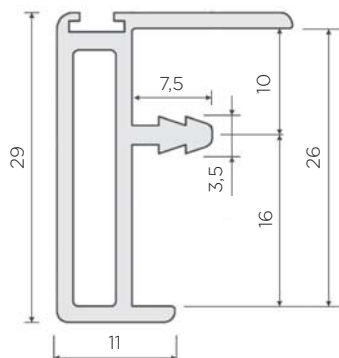

Šifra	Naziv	Dolžina mm
092172	173 Alu slepi ročaj za 25 mm L = 3000 mm	3000
092169	O66 Krtačka tesnilna za ročaj 25 mm	



krtačka

DOLGI ALUMINIJASTI ROČAJI



ALUMINIJASTI ROČAJ ZA 18 in 19 MM



Šifra	Naziv	Dolžina mm
92418	Bridge 600 Ročaj za iveral L = 3050 mm	3050
92421	Bridge 500 Krtačka za pokončni profil	
92422	Bridge 500 Tesnilo za pokončni profil	



ročaj



krtačka



tesnilo

HORIZONTALNI "T" PROFIL ZA IVERAL



Šifra	Naziv	Dolžina mm
92420	Bridge 600 Horizontalni T profil za iveral L = 2200 mm	2200

- dve možnosti montaže profila za več ustvarjalnosti

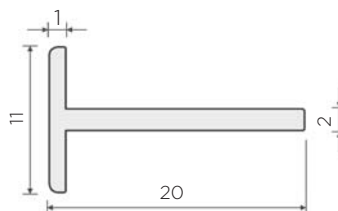
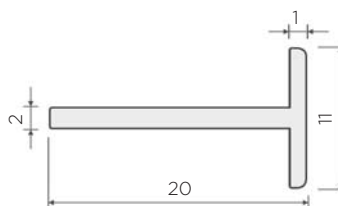

SLEPI ROČAJ ZA IVERAL

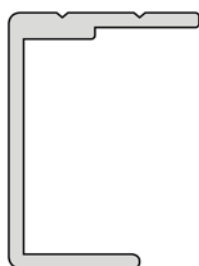

Šifra	Naziv	Dolžina mm
92419	Bridge 600 Slepí ročaj za iveral L = 3050 mm	3050

DOLGA ALUMINIJASTA ROČAJA



ALUMINIJASTI ROČAJ



Šifra	Naziv	Dolžina mm
390384	1101 Alu pohištni ročaj L=2500 mm	2500

- obdelava: eloxiran aluminij

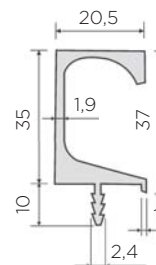

ALUMINIJASTI ROČAJ



Šifra	Naziv	Dolžina mm
390393	1201 Alu pohištni ročaj L = 3000 mm	3000

- obdelava: eloxiran aluminij

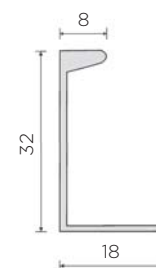

OKRASNI PROFILI, DOLGI POHIŠTVENI ROČAJI



OKRASNI ALUMINIJASTI PROFIL



Šifra	Naziv	Dolžina mm
092197	642 Alu okrasni profil 8 mm L = 3000mm	3000

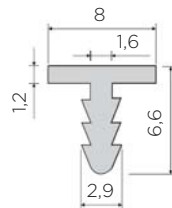

OKRASNI ALUMINIJASTI PROFIL



Šifra	Naziv	Dolžina mm
092248	620 Alu obroba za iveral 19 mm L = 4100 mm	4100

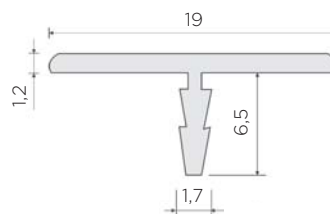

ALUMINIJASTA OBROBA ZA 19 MM



Šifra	Naziv	Dolžina mm
095329	Alu obroba za iveral 19 mm L = 5000 mm	5000

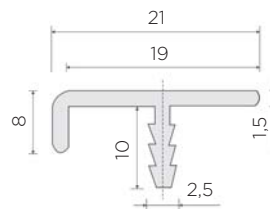

ALUMINIJASTI ROČAJ



Šifra	Naziv	Dolžina mm
092249	825 Alu pohištveni ročaj L = 3000 mm	3000

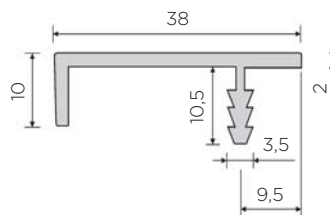

ALUMINIJASTI ROČAJ ZA 19 MM



Šifra	Naziv	Dolžina mm
092174	031 Alu vratni ročaj za 19 mm L = 2050 mm	2050

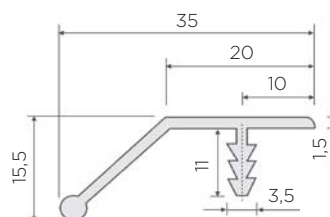



IZVLEČNI OBEŠALNIKI



IZVLEČNI OBEŠALNIK EGO1



Šifra	Naziv	W mm
099917	Ego1 Obešalnik izvlečni 45/60 cm bel	450-600
099901	Ego1 Obešalnik izvlečni 45/60 cm siv	450-600
099918	Ego1 Obešalnik izvlečni 60/83 cm bel	600-830
099902	Ego1 Obešalnik izvlečni 60/83 cm siv	600-830
099919	Ego1 Obešalnik izvlečni 83/115 cm bel	830-1150
099903	Ego1 Obešalnik izvlečni 83/115 cm siv	830-1150
099911	Egobasimuro/9 Držalo zadnje za Ego alu	

- max. obremenitev: 12/15 kg

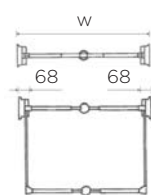
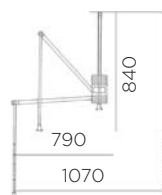

Egobasimuro/9

IZVLEČNI OBEŠALNIK EGO2



Šifra	Naziv	Širina mm
099900	EGO2 Obešalnik izvlečni 75/117 cm alu	750-1170

- max. obremenitev: 12 kg

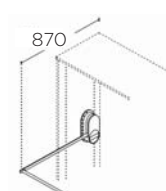
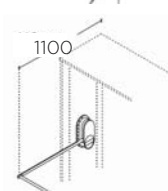
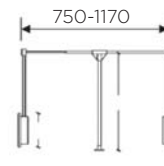
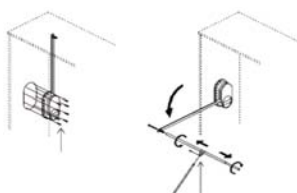

montaža na sredino omare

montaža na zadnji rob omare

IZVLEČNI OBEŠALNIK EGO3



Šifra	Naziv	Širina mm
099920	EGO3 Obešalnik izvlečni 45/60 cm siv	450-600
099921	EGO3 Obešalnik izvlečni 60/83 cm siv	600-830
099922	EGO3 Obešalnik izvlečni 83/115 cm siv	830-1150

- max. obremenitev: 15 kg

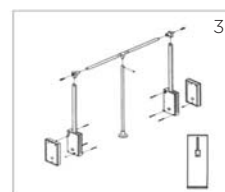
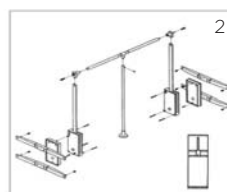
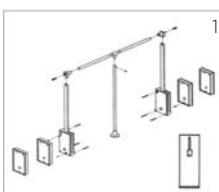

IZVLEČNI OBEŠALNIK EGO50

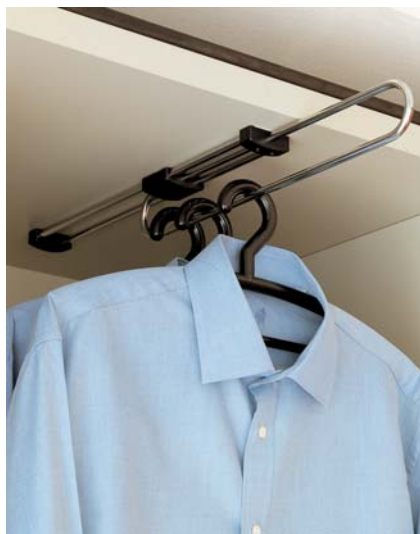

Šifra	Naziv	L mm
099914	EGO50 Obešalnik izvlečni 35 cm	350
099915	EGO50 Obešalnik izvlečni 40 cm	400
099912	EGO50 Obešalnik izvlečni 45 cm	450
099916	EGO50 Obešalnik izvlečni 50 cm	500

- material: kovina/PVC
- obdelava: krom

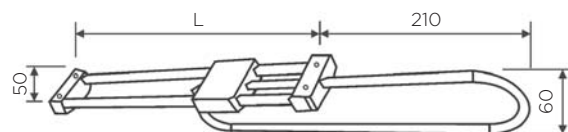

OBEŠALNIK EGO7 ZA HLAČE



Šifra	Naziv
099905	EGO7 Obešalnik za hlače aluminij

- material: aluminij
- obdelava: krom
- za 4 hlače

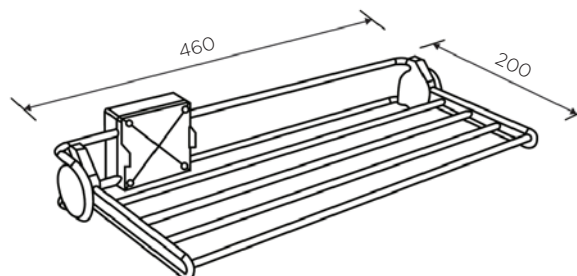

OBEŠALNIK EGO9 ZA KRAVATE IN PASOVE



Šifra	Naziv
099906	EGO9 Obešalnik za kravate aluminij

- obdelava: videz aluminija

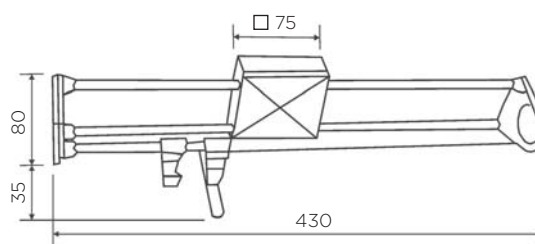

NOSILEC ZA ČEVLJE, IZVLEČNI OBEŠALNIKI



NOSILEC EGO20 ZA ČEVLJE



Šifra	Naziv
099907	EGO20 Nosilec za čevlje 460/700 aluminij

- obdelava: videz aluminija
- nastavljiva dolžina: 460-700 mm

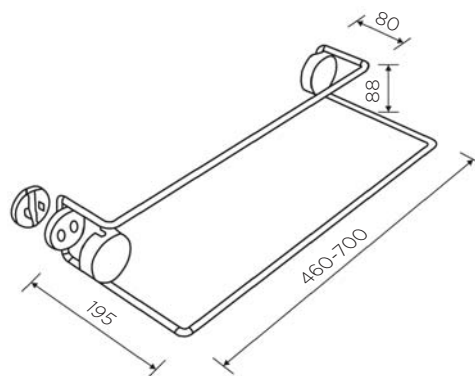

STARMAN

IZVLEČNI OBEŠALNIK



Šifra	Naziv	L mm
080120	Obešalnik izvlečni 25 cm	250
080121	Obešalnik izvlečni 30 cm	300
080122	Obešalnik izvlečni 35 cm	350
080123	Obešalnik izvlečni 40 cm	400
080124	Obešalnik izvlečni 45 cm	450
080141	Obešalnik izvlečni 50 cm	500

- material: kovina/PVC
- obdelava: krom

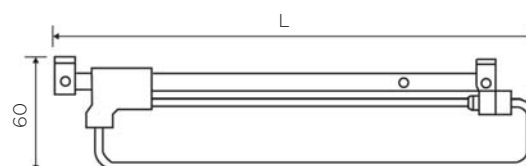

IZVLEČNI OBEŠALNIK ZA BRISAČE



Šifra	Naziv	Dolžina mm	Višina mm
390550	Obešalnik izvlečni za brisače 330 mm alu	330	92
390551	Obešalnik izvlečni za brisače 453 mm alu	453	92

- material: aluminij
- obdelava: srebrno mat eloksan

IZVLEČNA OBEŠALNIKA ZA HLAČE

STARMAN

IZVLEČNI OBEŠALNIK ZA 10 HLAČ



Šifra	Naziv	Višina mm	Širina mm	Globina mm
099908	Obešalnik izvlečni za 10 hlač	100	405	350

- material: jeklo
- obdelava: konstrukcija belo cinkano, obešalniki krom

IZVLEČNI OBEŠALNIK ZA 11 HLAČ



Šifra	Naziv	Višina mm	Širina mm	Globina mm
099913	Obešalnik izvlečni za 11 hlač	90	345	465

- material: jeklo
- obdelava: konstrukcija belo cinkano, obešalniki krom

OBEŠALNIKI

CONFALÖNIERI

OBEŠALNIK - KOVINSKI ULITEK



Šifra	Naziv
390623	PA00282 Obešalnik "Delta" mat krom

- material: kovinski ulitek
- obdelava: mat krom

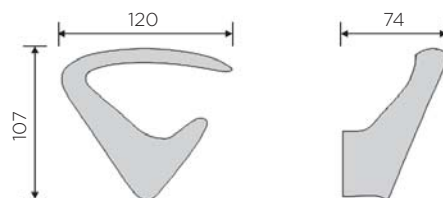

OBEŠALNIK - KOVINSKI ULITEK



Šifra	Naziv
390622	PA00281 Obešalnik mat krom

- material: kovinski ulitek
- obdelava: mat krom

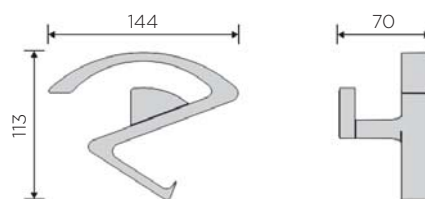

OBEŠALNIK - KOVINSKI ULITEK



Šifra	Naziv
390618	PA00271 Obešalnik mat krom

- material: kovinski ulitek
- obdelava: mat krom

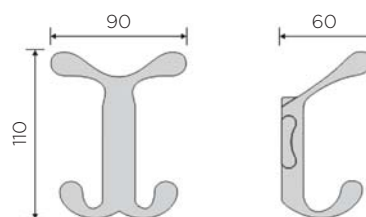

OBEŠALNIK - KOVINSKI ULITEK



Šifra	Naziv
390620	PA00273 Obešalnik mat krom

- material: kovinski ulitek
- obdelava: mat krom

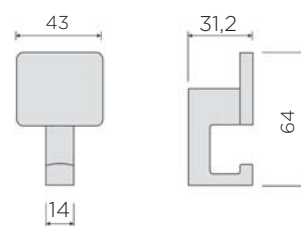

CONFALONIERI

OBEŠALNIK - KOVINSKI ULITEK



Šifra	Naziv
390621	PA00275 Obešalnik mat krom

- material: kovinski ulitek
- obdelava: mat krom

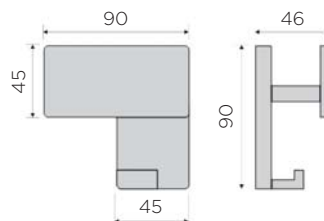

OBEŠALNIK - KOVINSKI ULITEK IN NAJLON



Šifra	Naziv
390625	PA00284 Obešalnik mat krom

- material: kovinski ulitek, najlon
- obdelava: mat krom

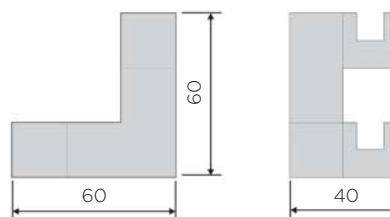

OBEŠALNIK Z OGLEDALOM



Šifra	Naziv	Število obeš.
390624	PA00283 Obešalnik z ogledalom siv	1

- okvir: najlon
- obešalnik: aluminij
- obdelava: sivo metalizirano
- obešalnik se lahko zapre v ogledalo

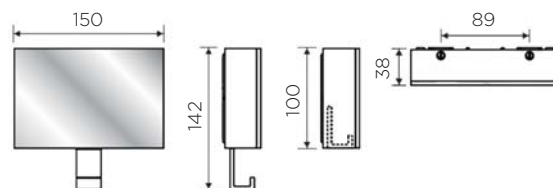

OBEŠALNIK Z OGLEDALOM

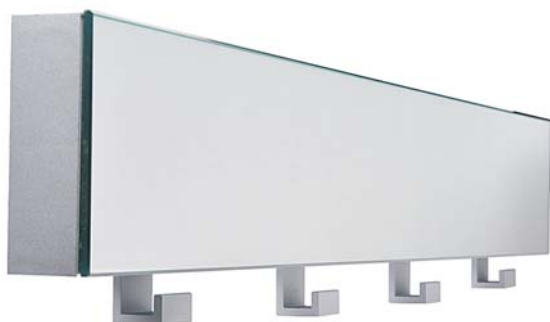

Šifra	Naziv	Število obeš.
390626	PA01283 Obešalnik z ogledalom siv	4

- okvir: najlon
- obešalnik: aluminij
- obdelava: sivo metalizirano
- obešalnik se lahko zapre v ogledalo

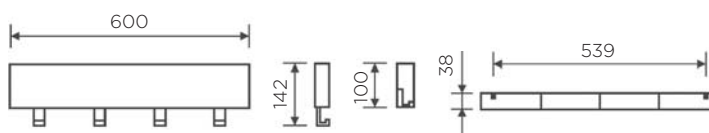

OBEŠALNIKI



OBEŠALNIK - ALUMINIJ



Šifra	Naziv	Število obeš.	Dolžina mm	Višina mm
390477	428,47,150 Obešalnik 2x - mat eloksiran	2	150	40
390478	428,47,220 Obešalnik 3x - mat eloksiran	3	220	40
390479	428,47,300 Obešalnik 4x - mat eloksiran	4	300	40

- obdelava: mat eloksiran

OBEŠALNIK - ALUMINIJ



Šifra	Naziv	Višina mm	Širina mm
390401	401,47,072x18 Obešalnik - mat eloksiran	72	18
390400	401,47,175x18 Obešalnik - mat eloksiran	175	18

- obdelava: mat eloksiran

OBEŠALNIK - ALUMINIJ



Šifra	Naziv	Višina mm	Širina mm
390403	402,47,078x68 Obešalnik - mat eloksiran	78	68
390402	402,47,175x68 Obešalnik - mat eloksiran	175	68

- obdelava: mat eloksiran

OBEŠALNIK - ZAMAK



Šifra	Naziv	Višina mm	Širina mm
390458	415,19,079x61 Obešalnik - inoxiran	79	61
390459	415,29,079x61 Obešalnik - krom	79	61
390460	415,30,079x61 Obešalnik - mat krom	79	61
390455	415,19,141x116 Obešalnik - inoxiran	141	116
390456	415,29,141x116 Obešalnik - krom	141	116
390457	415,30,141x116 Obešalnik - mat krom	141	116

- obdelava: glej tabelo



OBEŠALNIK - ZAMAK



Šifra	Naziv	Višina mm	Širina mm
390440	413,19,045x58 Obešalnik - inoxiran	45	58
390441	413,23,045x58 Obešalnik - pomedeninjen	45	58
390442	413,27,045x58 Obešalnik - mat nikelj	45	58
390443	413,29,045x58 Obešalnik - krom	45	58
390444	413,30,045x58 Obešalnik - mat krom	45	58
390435	413,19,114x90 Obešalnik - inoxiran	114	90
390436	413,23,114x90 Obešalnik - pomedeninjen	114	90
390437	413,27,114x90 Obešalnik - mat nikelj	114	90
390438	413,29,114x90 Obešalnik - krom	114	90
390439	413,30,114x90 Obešalnik - mat krom	114	90

- obdelava: glej tabelo

OBEŠALNIK - ZAMAK



Šifra	Naziv	Višina mm	Širina mm
390450	414,19,045x58 Obešalnik - inoxiran	45	58
390452	414,27,045x58 Obešalnik - mat nikelj	45	58
390453	414,29,045x58 Obešalnik - krom	45	58
390454	414,30,045x58 Obešalnik - mat krom	45	58
390445	414,19,127x125 Obešalnik - inoxiran	127	125
390447	414,27,127x125 Obešalnik - mat nikelj	127	125
390448	414,29,127x125 Obešalnik - krom	127	125
390449	414,30,127x125 Obešalnik - mat krom	127	125

- obdelava: glej tabelo

OBEŠALNIK - ZAMAK



Šifra	Naziv	Višina mm	Širina mm
390429	412,23,055x78 Obešalnik - pomedeninjen	55	78
390430	412,27,055x78 Obešalnik - mat nikelj	55	78
390431	412,29,055x78 Obešalnik - krom	55	78
390432	412,31,055x78 Obešalnik - mat krom lakiran	55	78
390433	412,39,055x78 Obešalnik - bel	55	78
390434	412,45,055x78 Obešalnik - črn	55	78
390423	412,23,160x78 Obešalnik - pomedeninjen	160	78
390424	412,27,160x78 Obešalnik - mat nikelj	160	78
390425	412,29,160x78 Obešalnik - krom	160	78
390426	412,31,160x78 Obešalnik - mat krom lakiran	160	78
390427	412,39,160x78 Obešalnik - bel	160	78

- obdelava: glej tabelo

OBEŠALNIKI



OBEŠALNIK - ZAMAK



Šifra	Naziv	Višina mm	Širina mm	Globina mm
390475	427,29,58x50 Obešalnik - krom	58	50	22
390476	427,30,58x50 Obešalnik - mat krom	58	50	22
390471	426,19,140x50 Obešalnik - inoxiran	140	50	59
390472	426,29,140x50 Obešalnik - krom	140	50	59
390473	426,30,140x50 Obešalnik - mat krom	140	50	59
390484	426,23,140x50 Obešalnik - pomedenin.	140	50	59

- obdelava: glej tabelo

OBEŠALNIK - ZAMAK



Šifra	Naziv	Višina mm	Širina mm	Globina mm
390556	436,19,47x70 Obešalnik inoxiran	47	70	25
390557	436,30,47x70 Obešalnik mat krom	47	70	25
390554	435,19,142x76 Obešalnik inoxiran	142	70	25
390555	435,30,142x76 Obešalnik mat krom	142	70	25

- obdelava: glej tabelo

OBEŠALNIK - ZAMAK



Šifra	Naziv	Višina mm	Širina mm
390559	437,36,65x83 Obešalnik broniran	65	83
390558	437,36,170x83 Obešalnik broniran	170	83

- obdelava: broniran antik

OBEŠALNIK - ZAMAK



Šifra	Naziv	Višina mm	Širina mm
390468	425,19,80x17 Obešalnik inoxiran	80	17
390469	425,29,80x17 Obešalnik krom	80	17
390470	425,30,80x17 Obešalnik mat krom	80	17
390465	424,19,155x17 Obešalnik inoxiran	155	17
390466	424,29,155x17 Obešalnik krom	155	17
390467	424,30,155x17 Obešalnik mat krom	155	17

- obdelava: glej tabelo



OBEŠALNIK - ZAMAK



Šifra	Naziv	Višina mm	Širina mm	Globina mm
390494	432,19,40x12 Obešalnik inoxiran	40	12	40
390497	432,16,40x12 Obešalnik črn	40	12	40

- obdelava: glej tabelo

OBEŠALNIK - ZAMAK



Šifra	Naziv	Višina mm	Širina mm	Globina mm
390495	433,19,40x52 Obešalnik inoxiran	40	52	40
390498	433,16,40x52 Obešalnik črn	40	52	40

- obdelava: glej tabelo

OBEŠALNIK - ZAMAK



Šifra	Naziv	Višina mm	Širina mm	Globina mm
390552	434,19,110x58 Obešalnik inoxiran	58	110	40
390553	434,30,110x58 Obešalnik mat krom	58	110	40

- obdelava: glej tabelo

OBEŠALNIK - ZAMAK



Šifra	Naziv	Višina mm	Širina mm	Globina mm
390496	431,19,72x29 Obešalnik inoxiran	29	72	38
390493	431,30,72x29 Obešalnik mat krom	29	72	38

- obdelava: glej tabelo

OBEŠALNIKI



OBEŠALNIK - ZAMAK



Šifra	Naziv	Višina mm	Širina mm	Razmik mm
390491	429,31,140x16 Obešalnik mat krom lak.	140	16	128

- obdelava: mat krom lakiran
- max. obremenitev: 10 kg

OBEŠALNIK - ZAMAK



Šifra	Naziv	Višina mm	Širina mm	Razmik mm
390492	430,31,80x20 Obešalnik mat krom lak.	80	20	66

- obdelava: mat krom lakiran
- max. obremenitev: 10 kg

OBEŠALNIK - INOX



Šifra	Naziv	Višina mm	Širina mm
390411	405,17,080x20 Obešalnik - satiniran inox	80	20
390410	405,17,150x20 Obešalnik - satiniran inox	150	20

- obdelava: satiniran inox

OBEŠALNIK - INOX



Šifra	Naziv	Višina mm	Širina mm
390413	406,17,090x50 Obešalnik - satiniran inox	90	50
390412	406,17,190x57 Obešalnik - satiniran inox	190	57

- obdelava: satiniran inox
- premer: ø 10 mm



OBEŠALNIK - JEKLO



Šifra	Naziv	Višina mm	Širina mm
390463	423,29,150x53/22 Obešalnik mali - krom	150	53
390464	423,30,150x53/22 Obešalnik mali - mat krom	150	53
390461	422,29,225x53/22 Obešalnik velik - krom	225	53
390462	422,30,225x53/22 Obešalnik velik - mat krom	225	53

- obdelava: glej tabelo

STARMAN

OBEŠALNIK - JEKLO



Šifra	Naziv	Višina mm	Širina mm
095580	Kljuka obešalna enojna K-50 bela	50	20
095581	Kljuka obešalna enojna K-50 črna	50	20
095582	Kljuka obešalna enojna K-50 siva	50	20
095583	Kljuka obešalna dvojna K-100 bela	100	20
095584	Kljuka obešalna dvojna K-100 črna	100	20
095585	Kljuka obešalna dvojna K-100 siva	100	20
095538	Kljuka obešalna dvojna K-140 bela	140	20
095539	Kljuka obešalna dvojna K-140 črna	140	20
095540	Kljuka obešalna dvojna K-140 siva	140	20

- barva: glej tabelo

OBEŠALNIK - JEKLO



Šifra	Naziv	Višina mm	Širina mm
095543	Kljuka obešalna oval K-180 bela	130	54
095544	Kljuka obešalna oval K-180 črna	130	54
095545	Kljuka obešalna oval K-180 siva	130	54
095546	Kljuka obešalna oval K-180 rjava	130	54
095547	Kljuka obešalna oval K-180 krom	130	54

- barva: glej tabelo

OBEŠALNIKI

STARMAN

OBEŠALNIK - JEKLO



Šifra	Naziv	Število obeš.	Višina mm
095590	Obešalnik K-200/3 beli	3	138
095591	Obešalnik K-200/3 črni	3	138
095592	Obešalnik K-200/3 sivi	3	138
095593	Obešalnik K-200/4 beli	4	138
095594	Obešalnik K-200/4 črni	4	138
095595	Obešalnik K-200/4 sivi	4	138
095596	Obešalnik K-200/5 beli	5	138
095597	Obešalnik K-200/5 črni	5	138
095598	Obešalnik K-200/5 sivi	5	138

- barva: glej tabelo

OBEŠALNIK - JEKLO



Šifra	Naziv	Višina mm	Širina mm
095586	Kljuka obešalna K-200 bela	138	54
095587	Kljuka obešalna K-200 črna	138	54
095588	Kljuka obešalna K-200 siva	138	54
095589	Kljuka obešalna K-200 krom	138	54

- barva: glej tabelo

OBEŠALNIK - JEKLO

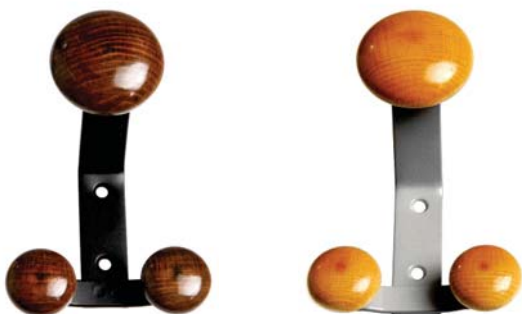

Šifra	Naziv	Višina mm	Širina mm
095530	Kljuka obešalna K-160 hrast črna	120	84
095531	Kljuka obešalna K-160 lužen hrast črna	120	84
095532	Kljuka obešalna K-160 hrast siva	120	84
095533	Kljuka obešalna K-160 češnja siva	120	84

- barva: glej tabelo

STARMAN

DVIŽNI MEHANIZEM ZA ČEVLJE



Šifra	Naziv
-------	-------

099576	Mehanizem dvižni za čevlje-dvojni
---------------	-----------------------------------

- material: ABS
- barva: bela

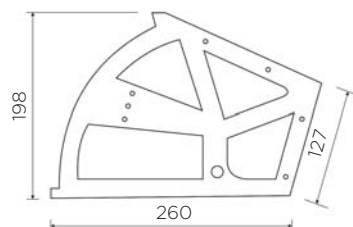

PODSTAVEK ZA MOKRO OBUTEV



Šifra	Naziv	Dolžina mm	Širina mm	Višina mm
-------	-------	------------	-----------	-----------

087193	Podstavek PVC za mokro obutev siv	315	255	7
---------------	-----------------------------------	-----	-----	---

- material: PVC

POHIŠTVENE KONZOLE, NOSILCI POLIC



STARMAN

POHIŠTVENA KONZOLA - BAROK



Šifra	Naziv	L mm
080174	Konzola Barok 15 cm krom	150
080175	Konzola Barok 15 cm mat krom	150
080167	Konzola Barok 23 cm krom	230
080173	Konzola Barok 23 cm mat krom	230
080170	Konzola Barok 35 cm krom	350
080179	Konzola Barok 35 cm mat krom	350

- material: jeklo
- obdelava: glej tabelo

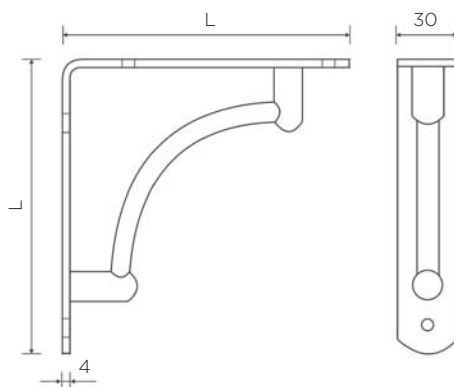

POHIŠTVENA KONZOLA - STILNA



Šifra	Naziv	L mm
080161	Konzola Stilna 15 cm krom	150
080171	Konzola Stilna 15 cm mat krom	150
080164	Konzola Stilna 23 cm krom	230
080172	Konzola Stilna 23 cm mat krom	230

- material: jeklo
- obdelava: glej tabelo

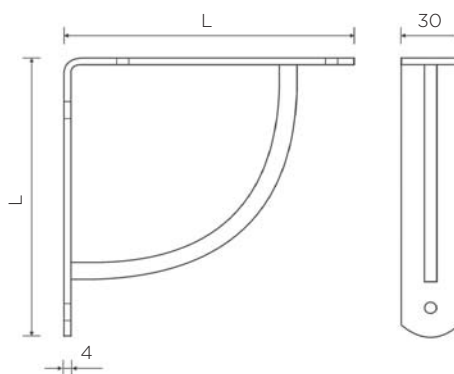

POHIŠTVENE KONZOLE

STARMAN

POHIŠTVENA KONZOLA - DS



Šifra	Naziv	L mm	h mm
095611	Konzola art. DS-18 cm bela	180	120
095612	Konzola art. DS-18 cm siva	180	120
095613	Konzola art. DS-24 cm bela	240	170
095614	Konzola art. DS-24 cm siva	240	170
095615	Konzola art. DS-30 cm bela	300	220
095616	Konzola art. DS-30 cm siva	300	220

- material: jeklo
- obdelava: prašno lakirano
- barva: glej tabelo

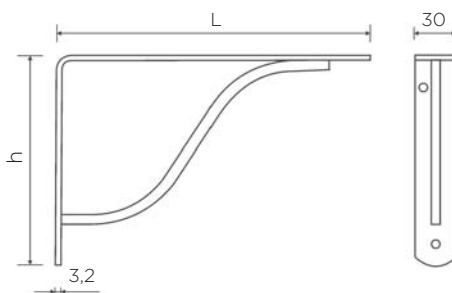

POHIŠTVENA KONZOLA - DM



Šifra	Naziv	Nosilnost kg	L mm	h mm
095599	Konzola art DM-18 cm bela	30	180	125
095600	Konzola art DM-18 cm siva alu	30	180	125
095601	Konzola art DM-18 cm črna	30	180	125
095602	Konzola art DM-18 cm rjava mix	30	180	125
095603	Konzola art DM-24 cm bela	35	240	170
095604	Konzola art DM-24 cm siva alu	35	240	170
095605	Konzola art DM-24 cm črna	35	240	170
095606	Konzola art DM-24 cm rjava mix	35	240	170
095607	Konzola art DM-30 cm bela	40	300	220
095608	Konzola art DM-30 cm siva alu	40	300	220
095609	Konzola art DM-30 cm črna	40	300	220
095610	Konzola art DM-30 cm rjava mix	40	300	220

- material: jeklo
- obdelava: prašno lakirano
- barva: glej tabelo

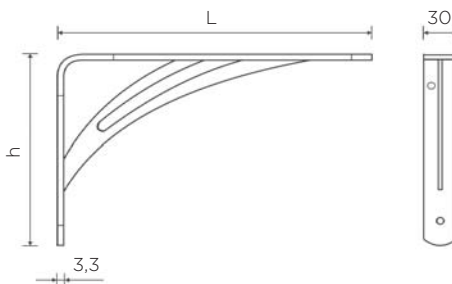

STARMAN

POHIŠTVENA KONZOLA - VT



Šifra	Naziv	Nosilnost kg	L mm	h mm
095467	Konzola art. VT-27 bela	55	270	175
095483	Konzola art. VT-27 siva	55	270	175
095468	Konzola art. VT-27 rjava	55	270	175
095466	Konzola art. VT-27 črna	55	270	175
095470	Konzola art. VT-33 bela	50	330	205
095502	Konzola art. VT-33 siva	50	330	205
095471	Konzola art. VT-33 rjava	50	330	205
095469	Konzola art. VT-33 črna	50	330	205
095473	Konzola art. VT-40 bela	45	400	255
095503	Konzola art. VT-40 siva	45	400	255
095474	Konzola art. VT-40 rjava	45	400	255
095472	Konzola art. VT-40 črna	45	400	255
095476	Konzola art. VT-50 bela	40	500	300
095504	Konzola art. VT-50 siva	40	500	300
095477	Konzola art. VT-50 rjava	40	500	300
595475	Konzola art. VT-50 črna	40	500	300

- material: kovina
- obdelava: barvano
- barva: glej tabelo

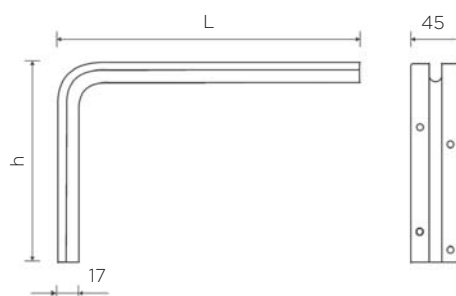

POHIŠTVENE KONZOLE

STARMAN

POHIŠTVENA KONZOLA - BZ



Šifra	Naziv	Nosilnost kg	L mm	h mm	w mm
095451	Konzola art. BZ-15 bela	20	150	120	25
095453	Konzola art. BZ-15 siva	20	150	120	25
095452	Konzola art. BZ-15 rjava	20	150	120	25
095450	Konzola art. BZ-15 črna	20	150	120	25
095455	Konzola art. BZ-20 bela	25	200	145	28
095457	Konzola art. BZ-20 siva	25	200	145	28
095456	Konzola art. BZ-20 rjava	25	200	145	28
095454	Konzola art. BZ-20 črna	25	200	145	28
095459	Konzola art. BZ-25 bela	30	250	160	30
095461	Konzola art. BZ-25 siva	30	250	160	30
095460	Konzola art. BZ-25 rjava	30	250	160	30
095458	Konzola art. BZ-25 črna	30	250	160	30
095463	Konzola art. BZ-30 bela	35	300	200	34
095465	Konzola art. BZ-30 siva	35	300	200	34
095464	Konzola art. BZ-30 rjava	35	300	200	34
095462	Konzola art. BZ-30 črna	35	300	200	34

- material: kovina
- obdelava: barvano
- barva: glej tabelo

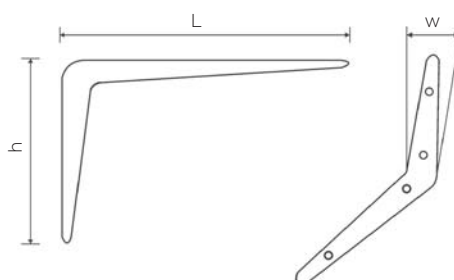

STARMAN

POHIŠTVENA KONZOLA - RAV



Šifra	Naziv	Nosilnost kg	L mm
095400	Konzola art. RAV-15 bela	25	150
095403	Konzola art. RAV-15 siva	25	150
095401	Konzola art. RAV-15 rjava	25	150
095404	Konzola art. RAV-20 bela	25	200
095407	Konzola art. RAV-20 siva	25	200
095405	Konzola art. RAV-20 rjava	25	200
095412	Konzola art. RAV-20 črna	25	200
095408	Konzola art. RAV-25 bela	20	250
095411	Konzola art. RAV-25 siva	20	250
095409	Konzola art. RAV-25 rjava	20	250
095413	Konzola art. RAV-25 črna	20	250

- material: kovina
- obdelava: barvano
- barva: glej tabelo

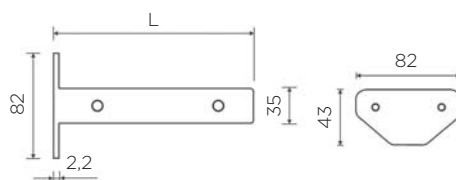

POHIŠTVENA KONZOLA - PK



Šifra	Naziv	Nosilnost kg	L mm	h mm
095672	Konzola preklopna PK-30	80	300	200
095673	Konzola preklopna PK-40	70	400	250

- material: jeklo
- obdelava: belo cinkano
- kot odpiranja: 70°, 80°, 90°

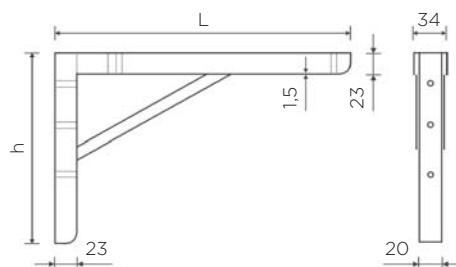

POHIŠTVENE KONZOLE

STARMAN

POHIŠTVENA KONZOLA - LC



Šifra	Naziv
095399	Konzola art. LC-18 cm bela
095520	Konzola art. LC-18 cm siva

- material: kovina
- obdelava: barvano
- barva: glej tabelo

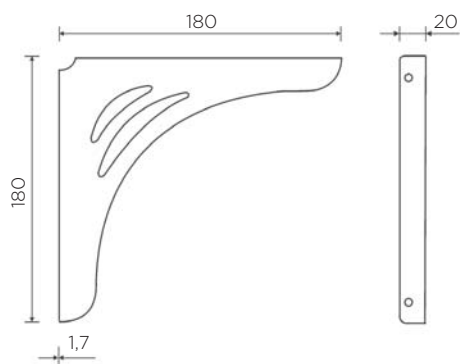

POHIŠTVENA KONZOLA - KN



Šifra	Naziv	L mm
095522	Konzola kotna art. KN-250x250 mm siva	250
095523	Konzola kotna art. KN-300x300 mm siva	300
095524	Konzola kotna art. KN-350x350 mm siva	350

- material: kovina
- obdelava: sivo barvano

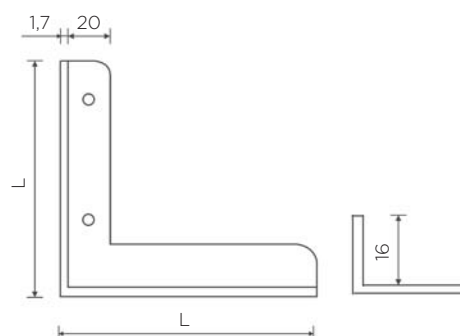

CONFAIÖNIERI

POHIŠTVENA KONZOLA - KOVINSKI ULITEK



Šifra	Naziv
390615	MS01432 Konzola 180 mm nastavljiva 4-45 mm mat-krom

- material: kovinski ulitek
- obdelava: mat-krom
- polietilenske čeljusti
- območje nastavljanja: 4-45 mm

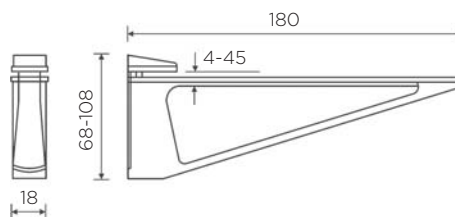

POHIŠTVENA KONZOLA - KOVINSKI ULITEK



Šifra	Naziv
390617	MS01437 Konzola 40x60 mm nast. 6-40 mm mat-krom

- material: kovinski ulitek
- obdelava: mat-krom
- polietilenske čeljusti
- območje nastavljanja: 6-40 mm

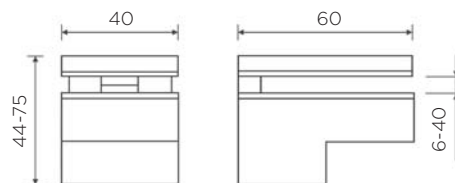

POHIŠTVENE KONZOLE



NASTAVLJIVA KONZOLA - ALUMINIJ



Šifra	Naziv
098000	450,19,6-38 mm Konzola - inoxirana
098001	450,29,6-38 mm Konzola - krom
098002	450,31,6-38 mm Konzola - mat krom lakirana

- obdelava: glej tabelo

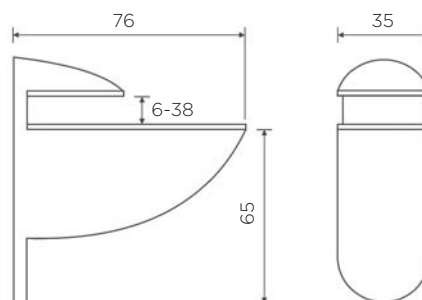

NASTAVLJIVA KONZOLA - ZAMAK



Šifra	Naziv	Dolžina mm
098010	451,19,5-20 mm Konzola - inoxirana	45
098011	451,30,5-20 mm Konzola - mat krom	45

- obdelava: glej tabelo

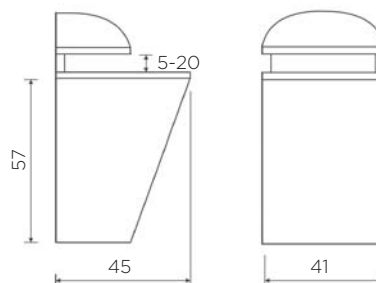

NASTAVLJIVA KONZOLA - ZAMAK



Šifra	Naziv	Dolžina mm	Širina mm
098013	452,19,5-50 mm Konzola - inoxirana	77	30
098014	452,31,5-50 mm Konzola - mat krom	77	30

- obdelava: glej tabelo

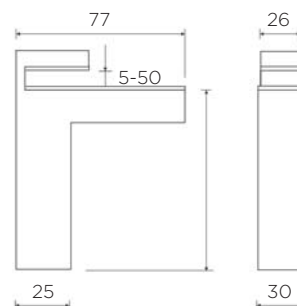

STARMAN

NASTAVLJIVA KONZOLA - ZAMAK



Šifra	Naziv	L mm	h mm	w mm
096501	Konzola nast. mini 0-10 mm 38 mm sat.	38	0-10	29
096507	Konzola nast. srednja 0-18 mm 75 mm sat.	75	0-18	32
095689	Konzola nast. srednja 0-18 mm 75 mm siva	75	0-18	32
096510	Konzola nast. velika 3-45 mm 112 mm siva	112	3-45	40

- obdelava: glej tabelo

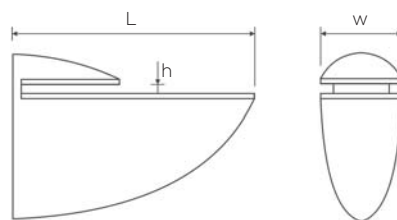

NASTAVLJIVA KONZOLA - ZAMAK



Šifra	Naziv
095686	Konzola nast. 0-40 mm L-180 mm siva

- barva: siva

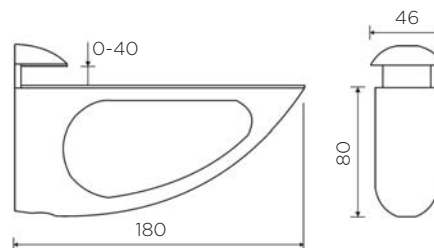

NASTAVLJIVA KONZOLA - ZAMAK



Šifra	Naziv
095687	Konzola nast. 4-30 mm L-100 mm siva

- barva: siva

- nastavljivo območje: 4-30 mm

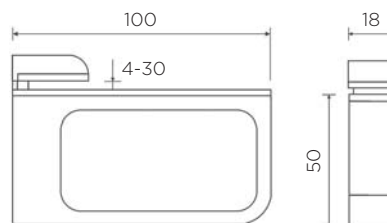

KONZOLE, STENSKE LETVE

STARMAN

KONZOLA - AU



Šifra	Naziv	Nosilnost kg	L mm	h mm
095478	Konzola art. AU-20 bela	20	200	52
095494	Konzola art. AU-20 siva	20	200	52
085483	Konzola art. AU-20 rjava	20	200	52
095488	Konzola art. AU-20 črna	20	200	52
095479	Konzola art. AU-25 bela	25	250	52
095495	Konzola art. AU-25 siva	25	250	52
095484	Konzola art. AU-25 rjava	25	250	52
095489	Konzola art. AU-25 črna	25	250	52
095480	Konzola art. AU-30 bela	30	300	64
095496	Konzola art. AU-30 siva	30	300	64
095485	Konzola art. AU-30 rjava	30	300	64
095490	Konzola art. AU-30 črna	30	300	64
095481	Konzola art. AU-35 bela	35	350	73
095497	Konzola art. AU-35 siva	35	350	73
095486	Konzola art. AU-35 rjava	35	350	73
095491	Konzola art. AU-35 črna	35	350	73
095482	Konzola art. AU-40 bela	40	400	73
095493	Konzola art. AU-40 siva	40	400	73
095487	Konzola art. AU-40 rjava	40	400	73
095492	Konzola art. AU-40 črna	40	400	73

- kovinska
- obdelava: barvano (glej tabelo)

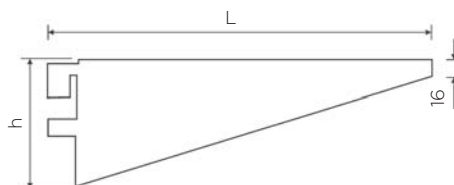

STENSKA LETEV - AU



Šifra	Naziv	L mm
095511	Stenska letev art. AU 4/100 bela	1000
095517	Stenska letev art. AU 4/100 siva	1000
095513	Stenska letev art. AU 4/100 rjava	1000
095515	Stenska letev art. AU 4/100 črna	1000
095510	Stenska letev art. AU 5/200 bela	2000
095516	Stenska letev art. AU 5/200 siva	2000
095512	Stenska letev art. AU 5/200 rjava	2000
095514	Stenska letev art. AU 5/200 črna	2000

- obdelava: barvano (glej tabelo)
- letve se pritrdijo na steno
- enostavna montaža konzol na letev
- letve so v barvah konzol



NASTAVLJIVA KONZOLA



NASTAVLJIVA KONZOLA - MINI



Šifra	Naziv
300025	Triade mini konzola nast. 15 kg L= max 300 mm

TRIAD E MINI je nastavljiva skrita konzola za montažo v polico debeline minimalno 25 mm. Lahko se nastavlja vertikalno in horizontalno. Prav tako pa se lahko nastavi tudi nagib police.

- material: cinkova zlitina, jeklo

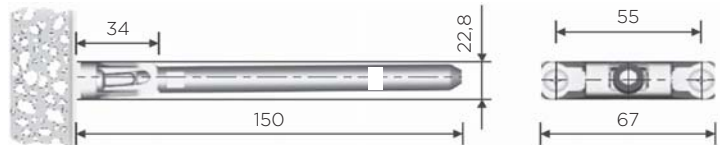

Pomembno:
nosilec mora biti z napisom obrnjen navzgor

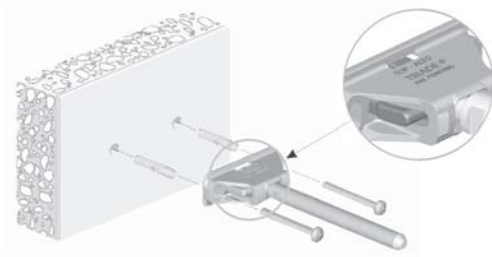

pritrnitev na betonsko steno

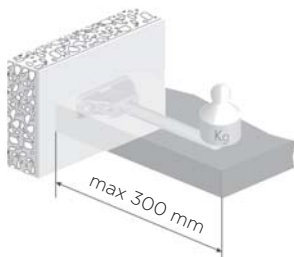

obremenitev + teža police = max 15 kg

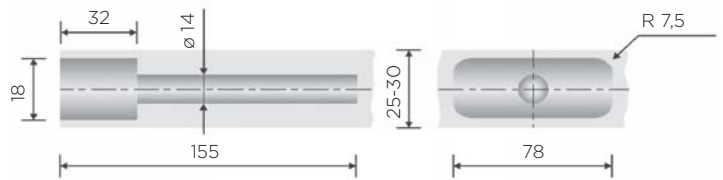
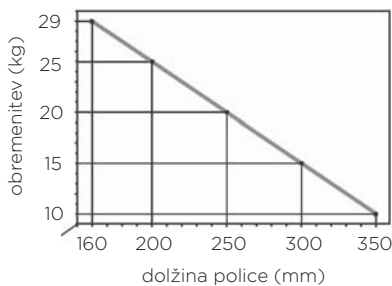

shema vrtnja za police debeline 25-30 mm

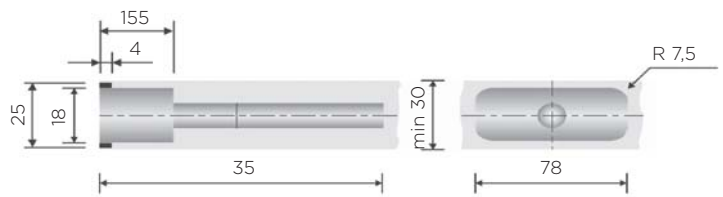

shema vrtnja za police debeline nad 30 mm



horizontalna nastavitvev



vertikalna nastavitvev

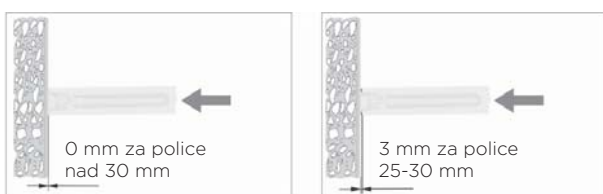

nastavitvev nagiba

NASTAVLJIVA KONZOLA



NASTAVLJIVA KONZOLA - MAXI



Šifra	Naziv
300026	Triade maxi konzola nast. 20 kg L= max 400 mm

TRIADE MAXI je nastavljiva skrita konzola za montažo v polico debeline minimalno 40 mm in širine minimalno 200 mm. Lahko se nastavlja vertikalno in horizontalno. Prav tako pa se lahko nastavi tudi nagib police.
- material: cinkova zlitina, jeklo

Pomembno:
nosilec mora biti z napisom obrnjen navzgor

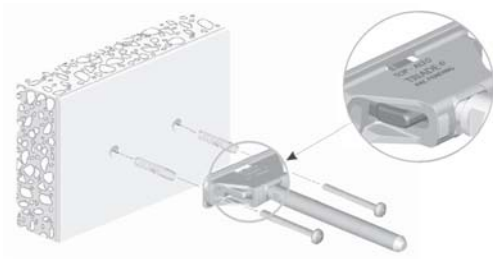

pritrnitev na betonsko steno

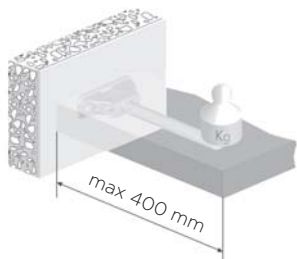

obremenitev + teža police = max 20 kg

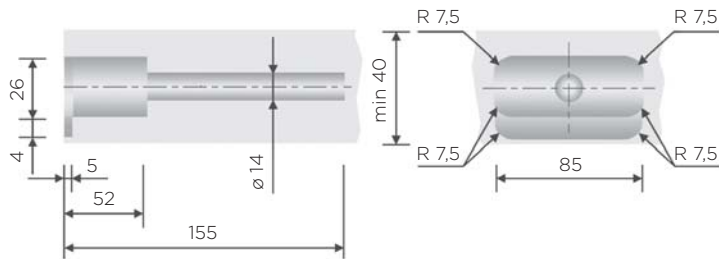
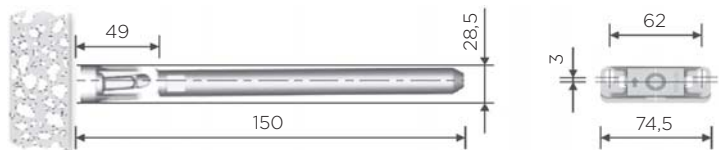
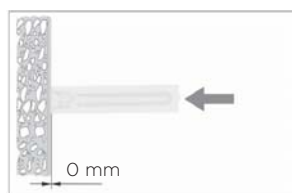

shema vrtanja



horizontalna nastavev

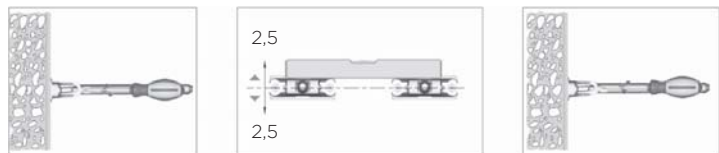

vertikalna nastavev



nastavev nagiba

STARMAN

NOSILEC POLICE



Šifra	Naziv	L1 mm	L2 mm	D1 (\varnothing) mm	D2 (\varnothing) mm
095679	Nosilec polic 9x90 plast. rjav	90	50	9	12
095681	Nosilec polic 12x120 plast. rjav	120	75	12	12
095682	Nosilec polic 14x140 plast. rjav	140	75	14	14

- material: jeklo
- obdelava: prevlečen s plastiko

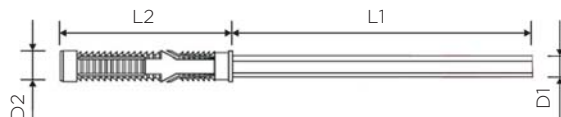

NOSILEC POLICE NA EXCENTER



Šifra	Naziv	Pak.
095542	Nosilec polic na excenter fi 12x120 mm	par

- material: jeklo
- obdelava: belo cinkano
- ekscenter za regulacijo
- podložka: 16x8,5x1,5 mm
- vložek: 10x60 mm

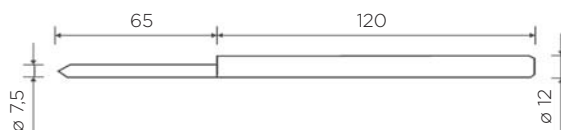

NOSILEC STEKLENE POLICE NA EXCENTER



Šifra	Naziv
080313	Nosilec steklene police krom

- material: jeklo
- obdelava: krom
- ekscenter za regulacijo
- podložka: 22x10x5 mm



NOSILCI STEKLENIH POLIC



NOSILEC STEKLENE POLICE



Šifra Naziv

095252 Nosilec polic za steklo enojni-vijak

- material: medenina
- obdelava: nikljan
- luknja: 8 mm
- za debelino stekla: 6-8 mm

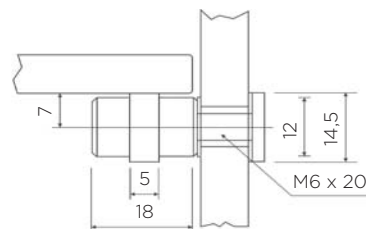

NOSILEC STEKLENE POLICE



Šifra Naziv

095254 Nosilec polic za steklo dvojni

- material: medenina
- obdelava: nikljan
- luknja: 8 mm
- za debelino stekla: 6-8 mm

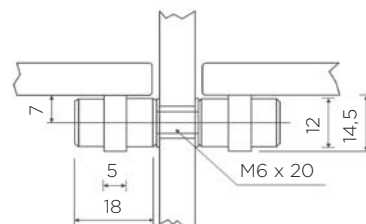

NOSILEC STEKLENE POLICE



Šifra Naziv

170214 Nosilec polic za steklo fi 5x11 mm

- material: jeklo
- obdelava: nikljan
- 2 gumijasta O obročka

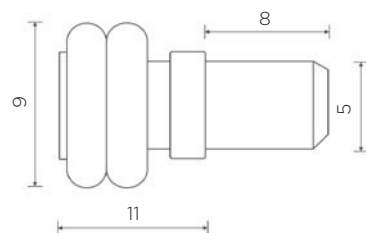

NOSILEC STEKLENE POLICE



Šifra Naziv

170312 Nosilec polic za steklo fi 3x11 mm

- material: jeklo
- obdelava: nikljan
- 2 gumijasta O obročka

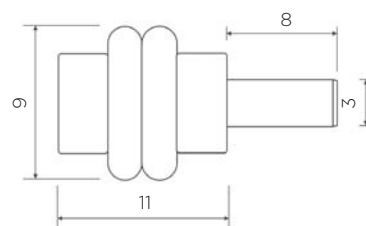

NOSILCI IN DRŽALA ZA STEKLENE POLICE

STARMAN

NOSILEC STEKLENE POLICE



Šifra Naziv

095847 Nosilec steklene police fi 5 mm - 2 centa

- material: jeklo
- obdelava: belo cinkano
- prozorna plastična kapica

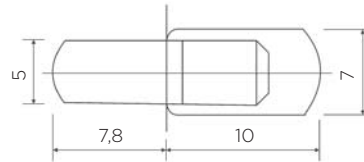

NOSILEC STEKLENE POLICE



Šifra Naziv

Pak.

080310 Nosilec steklene police 100 kos

cent

- material: kovina
- obdelava: nikljan

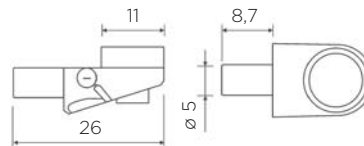

DRŽALO STEKLENE POLICE



Šifra Naziv

L
mm

Pak.

095926 Držalo stekla prozoren L = 3,3 mm (čepa)

3,3

cent

095924 Držalo stekla prozoren L = 6 mm (čepa)

6

cent

095925 Držalo stekla prozoren L = 9,5 mm (čepa)

9,5

cent

- material: PVC
- obdelava: prozoren

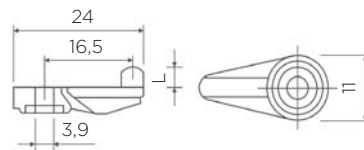

DRŽALO STEKLENE POLICE



Šifra Naziv

080334 Nosilec polic za steklo "Packman" 4-10 mm

- obdelava: nikljan
- enostavna pritrditev ali popustitev police s pritiskom na stranska gumba

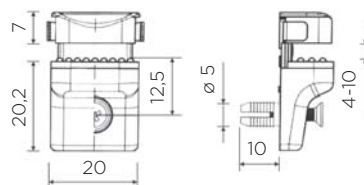

STARMAN

DRŽALA ZA STEKLENE POLICE IN OGLEDALA



DRŽALO STEKLENE POLICE



Šifra	Naziv
095903	X-Držalo za steklo-mali 6-8 mm mat nikel
095904	X-Držalo za steklo-veliki 6-8 mm mat nikel

- material: zamak
- obdelava: mat nikel

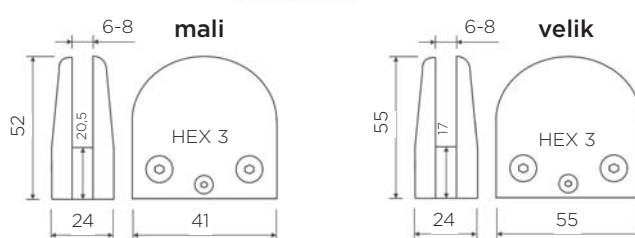
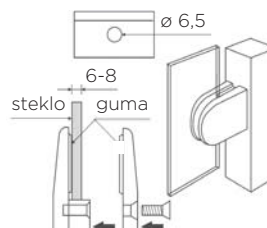

DRŽALO STEKLENE POLICE



Šifra	Naziv	Steklo mm
128017	X-Držalo stekla 15x16x27 mm 6-10 mm alu	6-10
128072	X-Držalo stekla 15x16x27 mm 6-10 mm krom	6-10

- material: zamak
- obdelava: glej tabelo

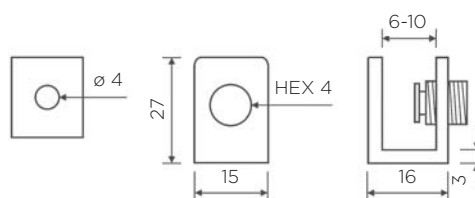

DRŽALA ZA OGLEDALA



Šifra	Naziv
128179	X-Držalo za ogledalo 4 del. krom

- obdelava: krom
- 2 zgornji držali z vzmetjo
- 2 fiksni spodnji držali
- luknja za vijake: Ø 5 mm
- za debelino ogledala 5 mm

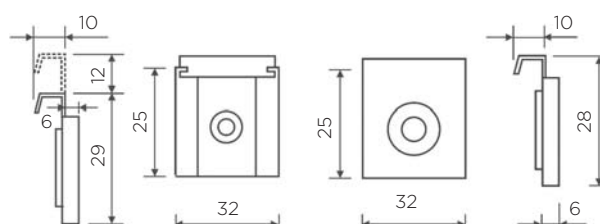

STARMAN

NOSILEC POLICE



Šifra	Naziv	Pak.
080105	Nosilec polic 5x24 mm beli cink 5 centov	5 cent
080149	Nosilec polic 5x24 mm rumeni cink 5 centov	5 cent
080150	Nosilec polic 5x24 mm črni cink 5 centov	5 cent

- material: jeklo
- obdelava: glej tabelo

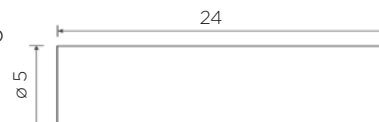

NOSILEC POLICE



Šifra	Naziv	Pak.
080097	Nosilec polic kov. z vencem	cent

- material: jeklo
- obdelava: belo cinkano

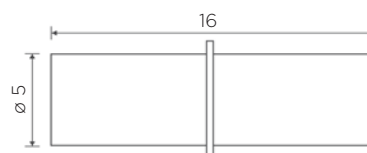

NOSILEC POLICE



Šifra	Naziv	Pak.
080190	Nosilec polic 3x17 nikelj 1 cent	cent

- material: jeklo
- obdelava: nikljan

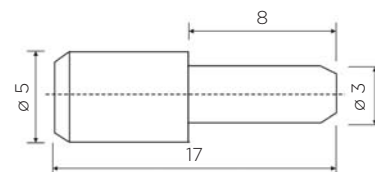

NOSILEC POLICE



Šifra	Naziv	Pak.
080098	Nosilec polic ploščati 133.00	cent

- material: jeklo
- obdelava: nikljan

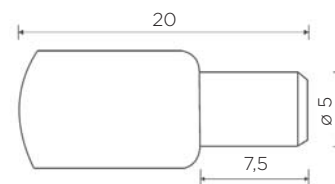

NOSILEC POLICE



Šifra	Naziv	Pak.
080327	Nosilec polic 5 mm 04.0087 nikelj	cent

- material: jeklo
- obdelava: nikljan

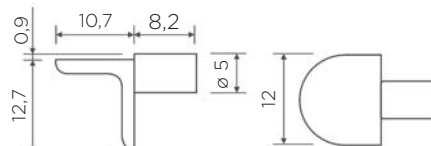

NOSILCI POLIC

STARMAN

NOSILEC POLICE



Šifra	Naziv	Pak.
095948	336.3553.650 Ni. nosilec polic + 1 čep	cent

- material: jeklo
- obdelava: nikljan

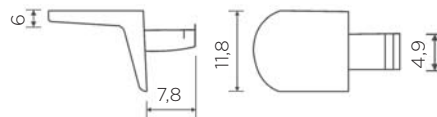

NOSILEC POLICE



Šifra	Naziv	Pak.
095923	336.3552.650 Ni. nosilec polic + 2 čepa	cent

- material: jeklo
- obdelava: nikljan

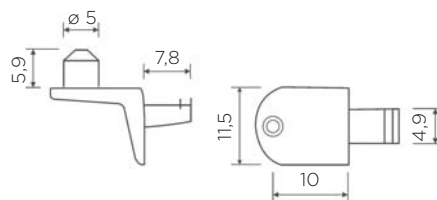

NOSILEC POLICE

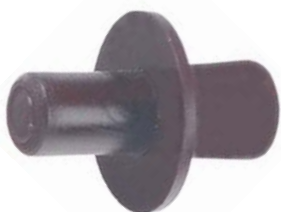

Šifra	Naziv	Pak.
080116	Nosilec polic 5/6 beli 2 centa	2 cent
080146	Nosilec polic 5/6 rjavi 2 centa	2 cent
080147	Nosilec polic 5/6 črni 2 centa	2 cent

- material: PE
- barva: glej tabelo

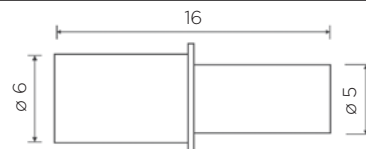

NOSILEC POLICE



Šifra	Naziv	Pak.
080117	Nosilec polic z žičnikom beli 2 centa	2 cent
080148	Nosilec polic z žičnikom rjavi 2 centa	2 cent

- material: PE
- barva: glej tabelo

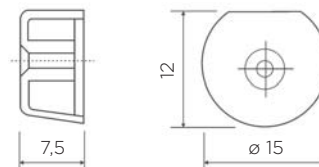

NOSILEC POLICE



Šifra	Naziv	Pak.
080104	Nosilec polic kotni PVC beli 2 centa	2 cent
080144	Nosilec polic kotni PVC rjavi 2 centa	2 cent
080145	Nosilec polic kotni PVC črni 2 centa	2 cent

- material: PE
- barva: glej tabelo

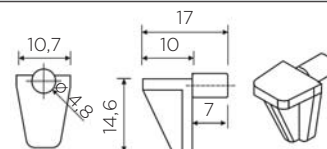

STARMAN

NOSILEC CEVI



Šifra	Naziv	Pak.
095702	Nosilec cevi oval stenski nikelj	cent

- material: zamak
- obdelava: nikljan

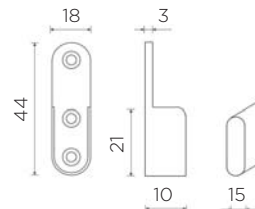

NOSILEC CEVI



Šifra	Naziv	Pak.
095685	Nosilec cevi fi 18 mm nikelj	cent

- material: kovinska zlitina
- obdelava: nikljan

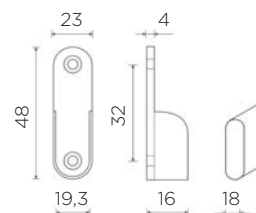

NOSILEC CEVI



Šifra	Naziv	Pak.
150830	Nosilec cevi oval stenski RAL 9006	cent

- material: kovinska zlitina
- obdelava: RAL 9006

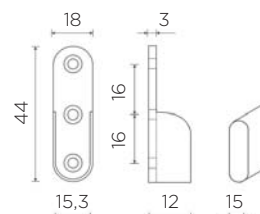

NOSILEC CEVI



Šifra	Naziv	Pak.
095704	Nosilec cevi oval stropni nikelj	cent

- material: kovinska zlitina
- obdelava: nikljan

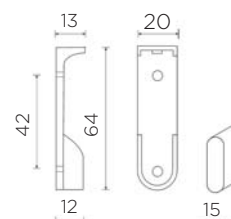

NOSILEC CEVI



Šifra	Naziv	Pak.
150832	Nosilec cevi oval stropni RAL 9006	cent

- material: kovinska zlitina
- obdelava: RAL 906

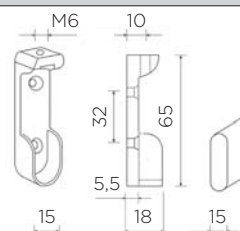

NOSILCI CEVI, CEVI

STARMAN

NOSILEC CEVI



Šifra	Naziv	Za cev mm	Pak. cent
095700	Nosilec cevi oval centralni - M6	15	cent

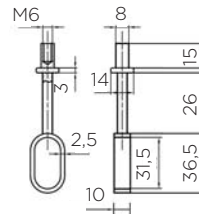

NOSILEC CEVI



Šifra	Naziv	Za cev mm	Pak. cent
095712	Nosilec cevi oval centralni za privijačit	18	cent

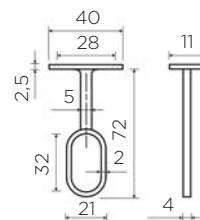

NOSILEC CEVI



Šifra	Naziv	Za cev mm	Pak. cent
095714	Nosilec cevi fi 25 mm z vijakom krom	25	cent

- material: jeklo
- obdelava: krom
- imbus vijak za pritrditev cevi

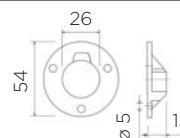

NOSILEC CEVI



Šifra	Naziv	Za cev mm	Pak. cent
095699	Nosilec cevi fi 18 mm rjav	18	cent
095698	Nosilec cevi fi 18 mm bel	18	cent

- material: PVC
- barva: glej tabelo

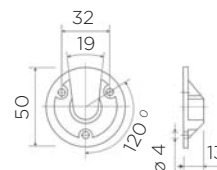

OKROGLA IN OVALNA CEV

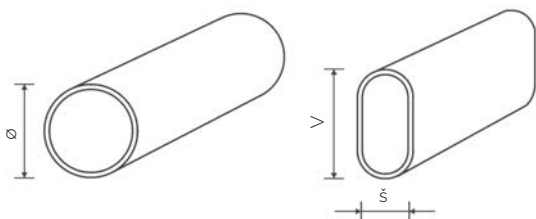

Šifra	Naziv	Dolžina mm	Premer (ø) mm	Š/V mm
150815	Cev okrogla fi 18x3000 mm bela	3000	18	
150816	Cev okrogla fi 18x3000 mm krom	3000	18	
150825	Cev okrogla fi 18x3000 mm rjava	3000	18	
165026	Cev okrogla fi 25x3000 mm krom	3000	25	
150802	Cev ovalna 15x22x3000 mm krom	3000		15/22
150807	Cev ovalna 15x30x3000 mm krom	3000		15/30
150829	Cev ovalna 15x30x3000 mm RAL9006	3000		15/30
150957	Cev ovalna 15x30x2900 mm aluminij	2900		15/30

- material: pločevina
- obdelava: glej tabelo

STARMAN

BLAŽILEC ZA VRATA - ZAMAK



Šifra	Naziv	Dolžina mm	Širina mm	Višina mm
150305	Blažilec za vrata Bike - mat nikelj	35	30	20
150306	Blažilec za vrata Bike - krom	35	30	20
150313	Blažilec za vrata Bike - mat krom	35	30	20
150314	Blažilec za vrata Bike - zlat	35	30	20

- obdelava: glej tabelo

BLAŽILEC ZA VRATA - INOX



Šifra	Naziv	Premer (ø) mm	Višina mm
123026	3691 Blažilec za vrata fi 30x40 mm inox	30	40

- material: inox

BLAŽILEC ZA VRATA



Šifra	Naziv	Premer (ø) mm
150315	Blažilec za vrata fi 35 mm bel	35
087211	Blažilec za vrata fi 35 mm siv	35
087210	Blažilec za vrata fi 35 mm rjav	35
087213	Blažilec za vrata fi 35 mm oker	35
087212	Blažilec za vrata fi 35 mm črn	35

- material: PVC
- barva: glej tabelo

SAMOLEPILNI BLAŽILEC ZA VRATA



Šifra	Naziv	Premer (ø) mm
150337	Blažilec samolepilni fi 40 mm bel	40
150916	Blažilec samolepilni fi 40 mm siv	40
150915	Blažilec samolepilni fi 40 mm rjav	40
150918	Blažilec samolepilni fi 40 mm oker	40
150917	Blažilec samolepilni fi 40 mm črn	40
150335	Blažilec samol. fi 40 mm prozorni	40

- barva: glej tabelo



BLAŽILEC ZA VRATA



Šifra	Naziv	Dolžina mm	Širina mm	Višina mm
390521	600,19,47x45 Blažilec za vrata - inoxiran	47	45	22
390522	600,29,47x45 Blažilec za vrata - krom	47	45	22
390523	600,30,47x45 Blažilec za vrata - mat kr.	47	45	22

- obdelava: glej tabelo

DRŽALA ZA OGRAJO

STARMAN

DRŽALO ZA OGRAJO



Šifra	Naziv
095501	Držalo za ograjo "L" 70 mm/50 belo
095507	Držalo za ograjo "L" 70 mm/50 sivo
095509	Držalo za ograjo "L" 70 mm/50 rjavo
095518	Držalo za ograjo "L" 70 mm/50 krom
095508	Držalo za ograjo "L" 70 mm/50 inox

- material: jeklo
- obdelava: glej tabelo
- zidni vložek in vijak priložena

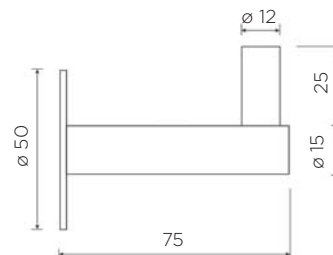

DRŽALO ZA OGRAJO



Šifra	Naziv	D mm
095498	Držalo za ograjo 65 mm/35 belo	35
095499	Držalo za ograjo 65 mm/35 sivo	35
095500	Držalo za ograjo 65 mm/35 rjavo	35
095506	Držalo za ograjo 65 mm/35 krom	35
095505	Držalo za ograjo 65 mm/35 medenina	35
095525	Držalo za ograjo 65 mm/50 inox	50

- material: jeklo
- obdelava: glej tabelo
- zidni vložek in vijak priložena

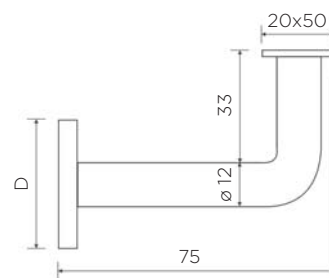

DRŽALO ZA OGRAJO



Šifra	Naziv
095519	Držalo za ograjo ravno 60 mm sivo

- material: jeklo
- obdelava: sivo barvano
- zidni vložek in vijak priložena

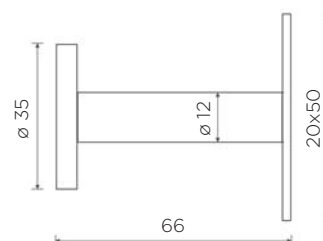

ROČAJI ZA OGRAJE, ZAKLJUČNI ČEPI

STARMAN

ROČAJ ZA OGRAJO



Šifra	Naziv	Premer (ø) mm
095351	Ročaj za ograjo fi 45 mm smreka	45
095352	Ročaj za ograjo fi 45 mm hrast	45
095353	Ročaj za ograjo fi 45 mm bukev	45
095354	Ročaj za ograjo fi 45 mm javor	45
095355	Ročaj za ograjo fi 45 mm jesen	45

- leseni ročaj
- obdelava: surov
- različne dolžine



ROČAJI LOK ZA LESENO OGRAJO



Šifra	Naziv	Kot	Premer (ø) mm
095340	Ročaj lok za ograjo fi 45 mm 30° bukev parjena	30°	45
095341	Ročaj lok za ograjo fi 45 mm 45° bukev parjena	45°	45
095342	Ročaj lok za ograjo fi 45 mm 90° bukev parjena	90°	45

Ročaji loki so prirezani na določen kot (90°, 45°, 30°), čelno obdelani za spajanje oziroma zaključevanje (izvrtine za moznični čep, posnet končni rob), pakirani v blister embalažo (priloženi so potrebni moznički in lepilo za les) in označeni z vsemi potrebnimi podatki za nemoteno manipulacijo in prodajo.

- material: bukev blago parjena

ZAKLJUČNI ČEPI ZA LESENO OGRAJO



Šifra	Naziv	Dolžina mm	Premer (ø) mm	Pak. kos
095343	Čep zaključni za ročaj fi 45 mm bukev p.	22,5	45	2
095344	Čep zaključni za ročaj fi 45 mm meden.	22,5	45	2
095345	Čep zaključni za ročaj fi 45 mm krom	22,5	45	2
095346	Čep zaključni za ročaj fi 45 mm siv	22,5	45	2
095347	Čep zaključni za ročaj fi 45 mm bel	22,5	45	2
095348	Čep zaključni za ročaj fi 45 mm rjav	22,5	45	2
095349	Čep zaključni za ročaj fi 45 mm inox	22,5	45	2

Zaključni čepi so obdelani za spajanje (izvrtina za moznični čep, posnet rob), pakirani v blister embalažo (priloženi so potrebni moznički in lesno lepilo) in označeni z vsemi potrebnimi podatki za nemoteno manipulacijo in prodajo.

Pripravil, izdal in založil Starman d.o.o., Poslovna cona Žeje pri Komendi, Pod brezami 2, 1218 Komenda.
Pridržujemo si pravice do sprememb in napak pri tisku. Slike v katalogu so lahko tudi simbolične.

STARMAN

Pohištveni ročaji obešalniki



Starman d.o.o.
Poslovna cona Žeje pri Komendi
Pod brezami 2
1218 Komenda

tel: (0)1 724 79 00
e-mail: info@starman.si

www.starman.si

STARMAN